

Electronic Theses and Dissertations, 2004-2019

2017

A Framework for Measuring Return on Investment for Healthcare Simulation-Based Training

Hatim Bukhari
University of Central Florida

 Part of the [Industrial Engineering Commons](#)
Find similar works at: <https://stars.library.ucf.edu/etd>
University of Central Florida Libraries <http://library.ucf.edu>

This Doctoral Dissertation (Open Access) is brought to you for free and open access by STARS. It has been accepted for inclusion in Electronic Theses and Dissertations, 2004-2019 by an authorized administrator of STARS. For more information, please contact STARS@ucf.edu.

STARS Citation

Bukhari, Hatim, "A Framework for Measuring Return on Investment for Healthcare Simulation-Based Training" (2017). *Electronic Theses and Dissertations, 2004-2019*. 5689.
<https://stars.library.ucf.edu/etd/5689>



A FRAMEWORK FOR MEASURING RETURN ON INVESTMENT FOR HEALTHCARE
SIMULATION-BASED TRAINING

by

HATIM ALI BUKHARI

B.S. Mechanical Engineering, King AbdulAziz University, Saudi Arabia, 2005

M.S. Engineering Management, Santa Clara University, United States, 2010

M.S. Industrial Engineering, University of Central Florida, United States, 2016

A dissertation submitted in partial fulfillment of the requirements
for the degree of Doctor of Philosophy
in the Department of Industrial Engineering and Management Systems
in the College of Engineering and Computer Science
at the University of Central Florida
Orlando, Florida

Fall Term
2017

Major Professor: Luis Rabelo

© 2017 Hatim Bukhari

ABSTRACT

In the healthcare sector, providing high-quality service in a safe environment for both patient and staff is an obvious and ultimate major objective. Training is an essential component for achieving this important objective. Most organizations acknowledge that employee simulation-based training programs are an important part of the human capital strategy, yet few have effectively succeeded in quantifying the real and precise ROI of this type of investment. Therefore, if the training is perceived as a waste of resources and its ROI is not clearly recognized, it will be the first option to cut when the budget cut is needed.

The various intangible benefits of healthcare simulation-based training are very difficult to quantify. In addition, there was not a unified way to count for the different cost and benefits to provide a justifiable ROI. Quantifying the qualitative and intangible benefits of medical training simulator needed a framework that helps to identify and convert qualitative and intangible benefits into monetary value so it can be considered in the ROI evaluation.

This research is a response to the highlighted importance of developing a comprehensive framework that has the capability to take into consideration the wide range of benefits that simulation-based training can bring to the healthcare system taking into consideration the characteristics of this specific field of investment. The major characteristics of investment in this field include the uncertainty, the qualitative nature of the major benefits, and the diversity and the wide range of applications.

This comprehensive framework is an integration of several methodologies and tools. It consists of three parts. The first part of the framework is the benefits and cost structure, which pays special attention to the qualitative and intangible benefits by considering the Value Measurement methodology (VMM) and other previously existing models. The second part of the framework is important to deal with the uncertainty associated with this type of investment. Monte Carlo simulation is a tool that considered multiple scenarios of input sets instead of a single set of inputs. The third part of the framework considers an advanced value analysis of the investment. It goes beyond the discounted cash flow (DCF) methodologies like net present value (NPV) that consider a single scenario for the cash flow to Real Options Analysis that consider the flexibility over the lifetime of the investment when evaluating the value of the investment. This framework has been validated through case studies.

I begin by praising ALLAH, the one who helped me to accomplish

To my dear father, Ali and my great mother, Fatheyah for their support over the years

To my beloved wife, Abrar and my precious kids, Jana, Jawad, Jenan, and Judy for their
inspiration, enthusiasm, and patience

To my sister, Lama, and my brothers for their support

To my friends and colleagues who have supported me

I dedicate this effort, which accomplished due to your prayers, support, and standing with me.

ACKNOWLEDGMENTS

First, I would like to thank my advisor, Dr. Luis Rabelo, for his boundless support, encouragement, and patience. This work could not have been accomplished without him. I would also like to thank my dissertation chairs and committee of Dr. Ahmad Elshennawy, Dr. Pamela Andreatta, and Dr. Brian Goldiez for their help and motivation.

Additional thanks go to all faculty and staff in the Department of Industrial Engineering and Management Systems and at the University of Central Florida for their help and support and for giving me the opportunity to be a part of this great institution.

In addition to that, I would like to express my appreciation and gratefulness for Dr. Luis Moya, Dr. Russ Saypoff, Dr. Rodrigo Rubio, and Dr. Tania Rocio Garibay for their valuable contribution to my research. They had a significant input that the research could not have been done without.

Additional thanks go to all faculty and staff in the Department of Industrial Engineering and Management Systems and at the University of Central Florida for their help and support and for giving me the opportunity to be a part of this great institution.

I am grateful to those individuals whose contributions and recommendations that streamlined the difficulties of pursuing my PhD, namely: Dr. Mohammad Basingab, Dr. John Pastrana, Dr. Murad Andejany, Dr. Hemaïd Alsulami, and Dr. Emad Abualsaud.

TABLE OF CONTENTS

LIST OF FIGURES	xii
LIST OF TABLES	xvi
CHAPTER 1 : INTRODUCTION	1
1.1 Introduction	1
1.2 Simulation in Medical Training	2
1.3 Return on Investment of Training and Development Programs	3
1.4 Components of Calculating Return on Investment	4
1.5 Problem Definition	5
1.6 The Importance of This Topic	6
1.7 Research Objective	7
1.8 Research Questions	8
1.9 Potential Contributions	8
1.10 Organization of the Document	9
CHAPTER 2 : REVIEW OF PREVIOUS RELATED LITERATURE	11
2.1 Introduction	11
2.2 Simulation-based Training and Education in Healthcare	12
2.3 Tangible and Intangible Value of Simulation and training	15
2.4 The Kirkpatrick-Phillips Model	16
2.5 Frost and Sullivan Model	18
2.6 Cost Savings from Reduced Catheter-Related Bloodstream Infection After Simulation-Based Education for Residents in a Medical Intensive Care Unit	21
2.7 ROI of an Educational Module and Simulation Learning Experience to Improve Medication Safety	24
2.8 The Modified Approach Based on Kirkpatrick-Phillips Model	26

2.8.1	Methodology Implementation Steps	27
2.9	Measuring ROI in Healthcare	32
2.10	Summary of Literature	33
2.11	Gap Analysis.....	39
CHAPTER 3 : METHODOLOGY		41
3.1	Research Methodology.....	41
3.2	Research Idea.....	43
3.3	Literature Review.....	43
3.4	Gap Analysis.....	44
3.5	Framework Development	44
3.5.1	Comparing Current Models.....	44
3.5.2	Study the Causal Relations of Factors	45
3.6	Framework.....	48
3.7	Validation Through Case Study.....	51
3.8	Analysis	52
3.9	Conclusion and Future Work.....	52
CHAPTER 4 : FRAMEWORK DEVELOPMENT.....		53
4.1	Introduction	53
4.2	Characteristics of Investments in Simulation-based Training in Healthcare	54
4.3	Simulation-based Healthcare Training Taxonomy	57
4.3.1	Taxonomy Methodology	58
4.3.2	Primary Categorization and Classification of Simulations Used in Healthcare Training	58
4.3.3	Secondary Categorization and Classification of Simulations Used in Healthcare Training	61
4.3.4	Taxonomy Validation	65
4.4	Comparing the Existing Models	67
4.4.1	Strengths and weaknesses of the Kirkpatrick-Phillips Model.....	67
4.4.2	Strengths and weaknesses of Frost and Sullivan Model.....	71

4.5	The benefits and cost structure	73
4.5.1	Benefits Structure	73
4.5.1.1	Key Measures and Factors Identification.....	75
4.5.1.2	Converting qualitative and quantitative measure to tangible values	77
4.5.1.2.1	Steps to Convert Measures to Monetary Values.....	77
4.5.1.3	Isolating and Evaluating the Impact of the Simulator	78
4.5.2	Cost Structure	79
4.5.2.1	Project phase cost	81
4.5.2.2	Operational phase cost	83
4.5.3	Summary of benefits and cost structure.....	84
4.5.4	Case Study of applying the benefits and cost structure of the framework.....	86
4.5.4.1	The cost structure of the simulation-based training.....	87
4.5.4.2	Identifying the key parameters and collecting the data	89
4.5.4.3	Converting qualitative and quantitative data into tangible values.....	89
4.5.4.4	Isolating the effects of the training	90
4.5.4.5	Calculating the ROI	91
4.5.4.6	Discussion	92
4.6	Value Analysis.....	93
4.6.1	Real Options Approach.....	94
4.6.2	Real Options Theory.....	95
4.6.2.1	Real Options Types.....	96
4.6.3	Procedure for determining the real option value (ROV) of the investment	97
4.6.3.1	Framing the application	98
4.6.3.2	Identifying the input parameter	98
4.6.3.3	Calculation of the option parameter.....	100
4.6.3.4	Generation of the binomial tree	100
4.6.3.5	Calculating the option values at each node by backward induction	101
4.6.4	The application of Real Options approach to the Case Study.....	102
4.6.4.1	Framing the application	102
4.6.4.2	Identification of input parameters.....	103
4.6.4.3	Calculation of input parameters.....	104
4.6.4.4	Generation of binomial tree.....	105

4.6.4.5	Calculating the options value at each node	106
4.6.4.6	Analyzing the results.....	110
4.7	Monte Carlo Simulation Analysis.....	111
4.7.1	Steps to create Monte Carlo Simulation.....	112
4.7.2	Return on investment evaluation	114
4.7.3	The application of Monte Carlo Simulation to the Case Study	115
4.8	The final ROI framework for simulation-based training in healthcare.....	119
CHAPTER 5 : CASE STUDY AND VALIDATION		121
5.1	Introduction	121
5.2	The Experiment of the environment	121
5.3	The benefits and cost structure	127
5.3.1	The benefits of the program	127
5.3.1.1	Key Measures and Factors Identification.....	128
5.3.1.2	Converting qualitative and quantitative measure to tangible values	128
5.3.1.2.1	Steps to Convert Measures to Monetary Values.....	128
5.3.1.3	Isolating and Evaluating the Impact of the Simulator	133
5.3.1.4	Summary of benefits structure.....	133
5.3.2	Cost Structure	134
5.3.2.1	Project phase cost	134
5.3.2.2	Operational phase cost	135
5.3.2.3	Summary of cost structure of the program.....	136
5.3.3	Summary of benefits and cost structure	137
5.4	Value Analysis and Real Option Approach	139
5.4.1	Framing the application.....	139
5.4.2	Identifying the input parameter	141
5.4.3	Calculation of the option parameters	141
5.4.4	Generation of the binomial tree	143
5.4.5	Calculating the option values by backward induction	144
5.4.6	Analyzing the results.....	147
5.5	Monte Carlo Simulation Analysis.....	148

5.5.1	Create a probability distribution for each input.....	148
5.5.2	Generate 1000 set of random inputs	151
5.5.3	Run the model.....	151
5.5.4	Analyzing the results.....	153
5.6	Discussion.....	154
5.7	Educational Efficiency and Effectiveness	154
5.8	Ethical clearance	155
CHAPTER 6 : CONCLUSION		156
6.1	Introduction	156
6.2	Contribution to the Body of Knowledge	160
6.3	Future Work.....	161
LIST OF REFERENCES		167

LIST OF FIGURES

Figure 2-1: Phillips ROI Model – Adapted From (Phillips, 2003).....	17
Figure 2-2: Quarterly catheter-related blood- stream infection (CRBSI) rates before and after a simulation-based educational intervention in the Medical Intensive Care Unit (MICU) (Cohen et al., 2010)	22
Figure 2-3: Summary of Kirkpatrick-Phillips Model	34
Figure 2-4: Summary of Frost and Sullivan Model	35
Figure 2-5: Summary of The Modified Approach Based on Kirkpatrick-Phillips Model.....	36
Figure 2-6: Summary of Measuring ROI in Healthcare Improvements Guid.....	37
Figure 2-7: Summary of Cohen, 2010 Paper.....	38
Figure 2-8: Summary of Durham, 2014 Paper	38
Figure 2-9: Summary of Existing Models and Gaps in Each Model	40
Figure 3-1: Research Methodology Diagram	42
Figure 3-2 Notations of components in system dynamics simulation model.....	46
Figure 3-3: Example of Causal Loop: Patient Satisfaction Sustainability Causal Model. Adopted from Faezipour and Ferreira (2013a)	47
Figure 4-1: Primary Categories of Simulation-based Training in Healthcare.....	60

Figure 4-2: Example of TraumaMan System	61
Figure 4-3: iStan is a wireless patient simulator with fully articulated movement and advanced features.....	62
Figure 4-4 Primary and Secondary Categories of Simulation-based Training in Healthcare	64
Figure 4-5: The benefits section of the benefits and cost structure	73
Figure 4-6: Isolating the effects of the training in the cost and benefits structure	74
Figure 4-7: The cost section of the benefits and cost structure	80
Figure 4-8: Project phase cost	81
Figure 4-9: Operational cost.....	83
Figure 4-10: Cost and Value Structure of Factors Contributing to ROI.....	85
Figure 4-11: Procedure for determining the ROV of the investment	97
Figure 4-12: The Binomial Tree	101
Figure 4-13: The binomial tree, with asset value, of option to adopt simulation-based training	105
Figure 4-14: The spreadsheet developed to calculate the option value	108
Figure 4-15: Binomial tree with option to adopt simulation-based training	109
Figure 4-16: The principal of stochastic uncertainty propagation.	112
Figure 4-17: The probability distribution of the expected benefits	116

Figure 4-18: The probability distribution of the expected benefits	117
Figure 4-19: ROI distribution	118
Figure 4-20: ROI Framework	120
Figure 5-1: Comparing the number of patients survived and died over 12-month period.....	122
Figure 5-2: The survivals rate at PICU	123
Figure 5-3: SOYUTZ Simulation-based training center	125
Figure 5-4: Training session in SOYUTZ simulation-based training center	125
Figure 5-5: Training on mannequin	126
Figure 5-6: Training on infant mannequin	126
Figure 5-7: Dr. Luis Rabelo visiting SOYUTZ and meeting the director Dr. Luis Moya.....	127
Figure 5-8: The binomial tree, with asset value, of option to adopt simulation-based training ..	143
Figure 5-9: The spreadsheet developed to calculate the option value	145
Figure 5-10: Binomial tree with option to adopt simulation-based training	146
Figure 5-11: The probability distribution of the expected mortality improvement	149
Figure 5-12: The probability distribution of the expected cost	150
Figure 5-13: ROI probability distribution	153

Figure 6-1: ROI Framework 159

Figure 6-2: The Matrix of Change. Adapted from (Elattar, 2014) 164

Figure 6-3: Case-Based Reasoning Cycle 166

LIST OF TABLES

Table 2-1: Year 1 Simulation-Based Training Cost Adjusted to 2008 Dollars.....	23
Table 4-1: Strengths and weaknesses of the Kirkpatrick-Phillips Model.....	70
Table 4-2: Strengths and weaknesses of Frost and Sullivan Model	72
Table 4-3: examples of the tangible and intangible factors.....	76
Table 4-4: Example of project and operational cost	82
Table 4-5: Details and totals of the cost of the training	88
Table 4-6: Analogy between financial and real options.....	95
Table 5-1: The survivals rate at PICU.....	122
Table 5-2: Simulation-based training outcomes	132
Table 5-3: The annual amount of change after the simulation-based training	133
Table 5-4: The discounted cash flow (DCF) of the program benefits	134
Table 5-5: Details and total of the project phase cost of the training	135
Table 5-6: Details and total of the operational phase cost of the training.....	136
Table 5-7: The discounted cash flow (DCF) of the program cost	137

Table 5-8: Summary of cost and benefits of the program.....	138
Table 5-9: The expected additional annual savings after the training	139
Table 5-10: The expected PV of savings of over 4 years before the training using DCF	140
Table 5-11: The expected PV of savings of over 4 years after the training using DCF	140
Table 5-12: Summary of inputs and option parameters	142
Table 5-13: A sample of 7 out of 100 sets of data that has been generated and analyzed.....	152

CHAPTER 1: INTRODUCTION

1.1 Introduction

Most organizations acknowledge that employee simulation and training programs are an important part of the human capital strategy, yet few have effectively succeeded in quantifying the real and precise ROI of this type of investment. Although some training benefits are intuitive, the focus should be on how these benefits eventually add value to the organization. The failure of human resource development to use the business language to correspond the financial impact of training could, unfortunately, result in a lack of investment in training and budget cuts (Estrada & Connolly, 2015).

In the healthcare sector, providing high-quality service in a safe environment for both patient and staff is an obvious and ultimate major objective. Training is an essential component for achieving this important objective. Organizations perceive training in four different ways: (a) an essential business process that is required for success, (b) as an added value that is worth to do, (c) as an optional and only nice to do process, and (d) as a waste of the resources of the business that does not return any benefit to the organization. Unfortunately, the dominant impression about training and performance improvement intervention perceives it as a nice to do but not a must, or even consider it a waste of resources and expenditure that does not pay itself back or make any return on the cost or investment spent on it (Roelandt, 2013). If the training is perceived as a waste of resources and its ROI is not clearly recognized, it will be the first option to cut when the budget cut is needed. The results of a survey of 1,200 training professionals conducted by Management Training and Development, Ltd (MTD) showed that 61% of the respondents experienced budget cuts or freezes as recession looms ("Training budgets cut as recession looms," 2008).

There are several forms of training, but one of the most important forms of medical training to obtain the required skills for achieving the ultimate goal of high-quality service in a safe environment for patients is exposing medical students and doctors to live patients. The real dilemma in exposing live patients to medical students who still do not possess sufficient knowledge and experience could increase the level of risk on patient life. Therefore, simulation-based training and education is an effective solution for this dilemma as it offers the opportunity for medical students and doctors the chance to practice without risking the lives of real patients, which provide the trainee the opportunity to focus on building the knowledge, skills, and experience and eliminate the tension that could hinder the learning process (Lateef, 2010).

Like any form of training, simulation training has a cost, and in some cases, it has a high cost. Organizations would always consider the benefits of any expenses. In fact, training is a form of investment in the human capital of the organization. Therefore, organizations need to have a tool or methodology to evaluate this type of investment. According to Luqman Hakim, Nur Naha Abu, and Nadiatulhuda (2015), return on investment (ROI) is one of the reliable investment evaluation tools that can be used to evaluate the financial benefits of training. This proper evaluation for investment in training would enable decision makers to make informed decisions regarding training alternatives and opportunities.

1.2 Simulation in Medical Training

Simulation in training is a technique that enables replacing the real experience with a created and controlled one. It enables simplifying as well as complicating the situation. In addition to that,

it empowers replication and imitation of real experience. Advanced simulators allow interaction to make the situation just like reality (Lateef, 2010).

For several years, military, aviation, nuclear power, and other industries used simulation for training and performance assessment. Recently, after the cumulative awareness of simulation-based training potentials and the increasing concerns about patient safety, the application and adoption of simulation in medical training have increased remarkably. In healthcare, simulation has a broad range of forms. It includes simple forms like using pig's feet for practicing suturing and complex forms as virtual reality machines (Jha, Duncan, & Bates, 2001).

Medical students and doctors need a safe way to do more practice in order to obtain and develop their knowledge, skills, and attitude. The practice of medical students and less experienced doctors on the real patient could risk an important aspect, which is patient safety. In addition to that, the stress and tension on the practitioner due to the high risk when practicing on the real patient would affect the learning process. Therefore, simulation-based training can be an essential solution that offers the chance for the learner to practice without stress or risk on real patients lives (Lateef, 2010). With simulation, medical professionals and healthcare staff are enabled to repeat practices and situations multiple times in order to improve and refine their skills. This is an important change in the learning process of the medical field (Lateef, 2008).

1.3 Return on Investment of Training and Development Programs

Executives need several inputs to make proper decisions, especially with the decisions that are associated with high expenditure. Unlike tangible investment, measuring the outcomes of

training and development programs is challenging. The root cause of this challenge is considering all the different effects on the different levels of the training. Therefore, the proper measurement of ROI requires the conversion of the qualitative and quantitative benefits of the training into a monetary value. Only then it can be considered to determine the return on investment on training (J. J. Phillips, 1997). Phillips states that measuring training results requires a detailed analysis and an evaluation framework. The value and the profitability of training need to be accurately projected and demonstrated to enable higher accuracy in ROI calculation and consequently, proper decision-making.

1.4 Components of Calculating Return on Investment

The general components that are required to calculate the ROI are the net cost and the net benefit of the expenditure or the venture. Therefore, in the case of training, the whole lifetime of the training program should be considered. Each component of these two major components has several sub-components and categories that need to be determined and calculated by the most accurate and appropriate methodologies in order to produce reliable inputs to the ROI calculation and consequently get reliable ROI outputs.

An example of the complex sub-components of the value of investing in training measures the performance improvement. This particular component has several techniques and guidelines for measuring performance. According to Bhasin (2008), organizations generally use generic measures with little consideration of their relevance. The selection of the right performance

measures for the appropriate level of organization for a specific application is challenging. According to Hussain and Gunasekaran (2002), the traditional performance measurements had a poor reflection of the real performance and that indicated the need for a new advanced management accounting system that considers the proper performance measurements tools and techniques.

Considering and incorporating the intangible values in ROI calculation is essential because it reflects the real value of the expenditure. It requires measuring the non-financial performance such as quality and customer satisfaction which is more difficult in service industries, like healthcare, than manufacturing (Hussain & Gunasekaran, 2002). In addition to that, the connection between financial and non-financial measures is fragile (Marshall & Heffes, 2004).

1.5 Problem Definition

The various intangible benefits of healthcare simulation-based training are very difficult to quantify. In addition, there is not a unified way to count for the different cost and benefits to provide a justifiable ROI. As a result, the real value of this type of training is not recognized by decision-makers to make well-informed investment decisions.

Quantifying the qualitative and intangible benefits of medical training simulator need a framework that helps to identify and convert qualitative and intangible benefits into monetary value so it can be considered in the ROI evaluation. The solution should consider the different possible aspects of benefits including operational, strategic, social, and any possible benefit result from the simulation-based training.

It is important for decision-makers in any investment to consider all the possible aspects of benefits of a project, including qualitative and quantitative. The consideration of quantitative benefits in ROI calculation is achievable since quantitative data can be directly transformed into monetary value. The difficult part to incorporate in the ROI analysis is the qualitative and intangible benefits. Therefore, the solution to this problem is expected to enable the integration of the different category of benefits, tangible and intangible, with the consideration of all the possible aspects of each category.

1.6 The Importance of This Topic

Understanding the real ROI and value of medical training, simulation is one of the most effective tools of it, and fostering the investment on it should have a positive impact on patient safety and quality of service, which are major objectives of the whole healthcare system. It is important to consider the wide range of benefits and values of simulation-based training including direct, social, operational, strategic, and financial values to enable more comprehensive evaluation for the ROI of the programs and as a result, proper investment decision-making regarding simulation-based medical training by its different forms. One example of an obvious added value that could be considered is the legal obligations and consequences that would be avoided by minimizing medical errors. According to Makary and Daniel (2016) is the third cause of death in the United States causing about 400,000 preventable death in 2013. This is a major value that could be credited to extensive training, which could be achieved by simulation-based one.

1.7 Research Objective

The objective of this dissertation is to develop a framework for determining the ROI of simulation-based training in the healthcare sector with the consideration the key tangible and intangible benefits that result from the training. Part of the framework should help in the process of identification of the key cost and benefits factors that should be included in the calculation of each specific simulation-based training. The framework will help in identifying the cost and benefits structure that determine the net cost and net benefit monetary value so it can be used to determine the ROI.

The study should serve as a guide to help executives and decision makers to make more informed decisions about investing in simulation training in the healthcare sector as it improves the accuracy and the credibility of the ROI, which is an essential investment evaluation tool.

This study will benefit healthcare organizations to properly realize the value of simulation-based training and as a result, should promote this type of training by justifying the investment on it. This will have a positive impact on the overall performance of healthcare providers and consequently on the wellbeing of the society.

1.8 Research Questions

This study will answer the following questions:

1. What are the different factors and benefits that should be considered when analyzing the ROI of a simulation-based training and how to identify them?
2. Why is it important to consider qualitative and intangible benefits in addition to the tangible and quantitative benefits when evaluating the ROI of simulation-based training?
3. How to quantify the qualitative and intangible benefits? and how to incorporate them into the evaluation process?

1.9 Potential Contributions

This dissertation will potentially offer the following contributions to the field of simulation training and investment evaluation:

1. A framework that enables a comprehensive determination of ROI of medical training simulation which, in turn, helps decision makers to make better-informed decisions that benefit the profitability and the performance of their organization. The framework will consider the various forms of benefits including the intangible and non-financial benefits. In addition to that, the framework will be applicable to the different forms of simulation-based medical training including the basic form of simulation which is the role-play, electronic or screen-based simulation, electronic human patient simulators, and different audiovisual systems.

2. This framework would improve the accuracy of ROI determination for simulation-based training in healthcare. This improvement will be the result of considering an important form of intangible benefits that has been widely neglected in current ROI evaluations. The improvement of accuracy will enhance the investment evaluation process of simulation-based training. In addition to that, the selection process between training alternatives will be more efficient and generate better outcomes for the organization. The success of this framework will open the door for its application in another form of training and in different industries.

3. The proper recognition for the value of simulation-based training will have an impact on the simulation industry and will promote and justify the investment in designing and building medical training simulator as well as the adoption of this form of training by healthcare organizations. This adoption will offer the opportunity to improve the training and development process for human resources and as a result, will improve the quality of service provided to patients as well as their safety .

1.10 Organization of the Document

After the introduction chapter, this dissertation will explore and review the literature to identify the efforts that have already been made regarding the area of evaluating the return on investment of simulation training in the healthcare field. This will include exploring and presenting a summary of what others have made to determine the ROI of simulation in healthcare. By further examination of the literature, some gaps will become distinct and these will be outlined in further details. After the identification of literature gaps, the research methodology will be

explained and the solution framework will be developed and described in details. Then, a case study will be used to demonstrate the application of the framework and will be used for the validation of the model. And finally, the conclusion will bring all of this information together and provide an applicable integrated framework that can determine the ROI for simulation-based training to help decision makers to make better-informed decisions.

CHAPTER 2: REVIEW OF PREVIOUS RELATED LITERATURE

2.1 Introduction

This chapter will address the past efforts that have already been put forth in this area of study and the gaps that are still remaining and require further research. Through these gapes, this research would justify the development of the integrated framework for determining the ROI of simulation-based training in healthcare.

In order to form a solid background about the different aspects that are related to the problem being considered, this literature review will start with investigating the adoption of simulation-based training and education in the healthcare field. This will consider the importance, the effectiveness, and the various forms of simulation-based training and education in healthcare. Then, this literature will explore the existing models that have been used to evaluate the ROI of different simulation-based training interventions in order to study the methodologies and the components that have been considered to build and implement these models. This is essential to understand and recognize the gap in the literature and form a solution that contribute to solving the defined problem and bridging that gap.

In the literature review process, there was a higher focus on the studies that considered the tangible and intangible value of simulation as the focus of the identified problem is on quantifying the qualitative and intangible benefits. In addition to that, ROI measuring tools and techniques for healthcare improvement projects and programs in general.

2.2 Simulation-based Training and Education in Healthcare

With the rapid changes in medical practices and the expanding alternatives for diagnosis and management, the opportunity to exercise the current practices could be limited. Therefore, simulation technology is an essential solution to gain, develop, and maintained the required knowledge and skills for healthcare providers (Issenberg, McGaghie, Hart, & et al., 1999). According to Issenberg, as of 1999 “four areas of high-technology simulations currently being used are laparoscopic techniques, which provide surgeons with an opportunity to enhance their motor skills without risk to patients; a cardiovascular disease simulator, which can be used to simulate cardiac conditions; multimedia computer systems, which includes patient-centered, case-based programs that constitute a generalist curriculum in cardiology; and anesthesia simulators, which have controlled responses that vary according to numerous possible scenarios.”

The basic form of simulation is the role-play, which can be described as a rehearsal for a future event. It is useful to test and change attitudes of learners, engage a group in active learning, develop critical thinking, and encourage synthesis and evaluation of information if it is performed in a controlled, structured and sensitive manner can be an immensely powerful learning tool (Clark, 2008). There are several other forms of simulation-based training. Electronic or screen-based simulation programs enable the trainee to learn away from the formal setting of the clinical or skills laboratory. This method offers multiple attempts for the trainee to practice and learn at the learner's own pace. Another type of simulation-based training is the electronic human patient simulators. The commonly used electronic human patient simulators including Laerdal Medical's ‘SimMan’ and ‘SimBaby’, METI's ‘iSTAN’ and Gaumard's ‘HAL’. These simulators are designed to imitate the physiological observations, sounds, and in some instances, actions of a real human patient. In addition to that, different audiovisual systems can be used for the purpose of training

simulation. This allows audio and video feeds to be recorded and broadcast to another area to overcome geographical and physical barriers such as conducting training for people in a remote location or for a bigger number of trainees (Aldridge & Wanless, 2012).

Improving patient safety, quality of care, and reducing the medication errors are the main focus of regulations. Yet the complexity of the medication administration procedure has increased the risk of making errors (Zimmerman, 2016). This has increased the importance of offering the service providers more opportunities to practice and master skills in a patient risk-free setting. Therefore, Greiner and Knebel (2003) considered simulation-based training and education as an essential component of an alternative skills, knowledge, and competencies development maintenance solutions. In addition to that, simulation-based training has a higher priority due to the increasing cost of medical errors in the hospital inpatient setting, curriculum structure, and preparation-practice gap (Zimmerman, 2016).

Acton, Chipman, Lunden, and Schmitz (2015) examined the variations over time between 2006 and 2014 of the formal teaching hours and assessed the cost of faculty members of the University of Minnesota, General Surgery Department and used an online survey that has been done in 2014 for general surgery program directors on the use of simulation-based education, training, and assessment and their perceptions of workload effects. The study found out that the aggregated number of hours that the department faculty members, residents, and students have spent in simulation events increased from 81 in the annual year 2006 to 365 in the annual year 2013. The approximated full-time faculty cost rose by 350% during the same period. The study concluded that the creativity in managing and building the instructors workforce is important to maintain the investment in simulation-based training over time and to avoid faculty burnout.

Addressing the insufficient discussion of how simulation may best be leveraged for training among the surgical specialties, Gardner et al. (2015) presented an overview of how simulation-based training is used to fulfill a wide range of needs of five surgical specialties.

Sanders and Wilson (2015) evaluated the use of simulation in obstetrics and gynecology residency programs in Canada. The study reported an increment in the integration of simulation-based training and education in obstetrics and gynecology residency programs, but it is still in early development stage. The study recommends a national standardization of the simulation curriculum to facilitate the integration of simulation into obstetrics and gynecology resident education and aid in the shift to competency-based resident assessment.

Miyasaka, Buchholz, LaMarra, Karakousis, and Aggarwal (2015) conducted a simulation-based curriculum to educate technical and nontechnical skills within a clinical pathway approach for a foregut surgery patient for Post Graduate Year 1 surgery residents. The curriculum is reinforced by a collective simulation repetitive pathway within the training days. The pathway is a series of simulated preoperative, intraoperative, and postoperative encounters in following up a single patient through a disease process. The overall operative performance ratings of faculty and self-ratings were improved significantly. Ratings of preoperative and postoperative performance were not significantly changed. The study concluded that pathway curriculum that targeted gaps in training methods by engaging technical and nontechnical skills into clinical context has shown a consistent improvement in performance evaluations as well as encourage the continuity to use the newly developed curriculum to educate surgery residents in foregut surgery.

2.3 Tangible and Intangible Value of Simulation and training

Simulation-based training can have multiple forms of benefits to healthcare organizations. Some benefits are tangible and easier to recognize like time-saving in operating room and procedures for example. The other form of value is the intangible value of simulation training which include, for example, employee and trainee satisfaction.

A major form of benefit that the simulation training can contribute to is preventing medical errors. According to Aspden (2006), more than 7 million serious, avoidable, medication errors occur in the yearly base, and over 50% of these errors happen during the course of inpatient care. The cost of preventable medical errors per year is shocking; it is about \$10.3 billion. In terms of U.S. hospital operational expense, medical errors cost about \$46 million per day which consume about 16% of patient care cost. Adverse drug events cost patient, family members, and healthcare providers from \$2,660 to \$8,650 over and above the cost of care and treatment (Zimmerman, 2016). Anel, Davidow, Hollander, and Moreno (2012) reported that In 2008, US bill of medical errors reached the \$19.5 billion and about 87 % of it was directly associated with an additional medical cost that could be prevented by avoiding errors. Brennan et al. (1991) estimated the total cost of medical injuries in New York to be \$3.8 billion in 1984, \$50 billion nationally. Thomas et al. (1999) estimated the total cost for errors to be \$662 million in 1996, \$308 million of that was related to preventable medical errors.

Since human resource is the major source of knowledge in firms, and it is a critical resource as it represents the mean and media to benefit from and use the knowledge, Zambrano, Merino, and Castellanos (2011) examined the influence of the investment in training and human resource development has over the total value of intangibles. The study results showed a positive

relationship between the two variables and concluded that investment in training employees generates increases in terms of the future intangible value of the firm.

2.4 The Kirkpatrick-Phillips Model

The work of J. J. Phillips and Phillips (2007) was used as a baseline to consider qualitative aspects related to value and ROI. Phillips recognized the organizations' need for a model that simplifies the data collection process in order to make informed investment decisions that can improve organizational training and performance. Therefore, Phillips developed an algorithm that helps to facilitate this process. Phillips expanded on Dr. Kirkpatrick's Four Levels of Evaluation for measuring performance in Training and Human Performance Technology (HPT) programs:

- Reaction (Level 1)
- Learning (Level 2)
- Behavior (Level 3)
- Results (Level 4)

Phillips expanded on Kirkpatrick's four levels by adding the "Fifth Level" of ROI Methodology for training and HPT programs. His adapted method evaluates the business value of the organization based on a particular investment or project to determine a framework for gathering program data to support and improve established training and performance programs. The following Figure 2-1 depicts Phillips's ROI model.

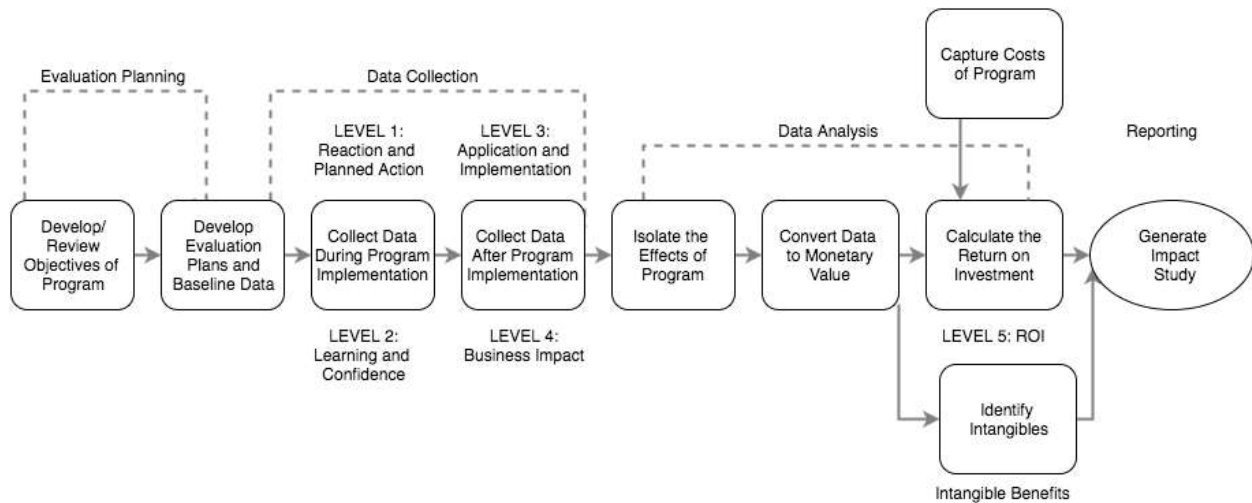

Figure 2-1: Phillips ROI Model – Adapted From (Phillips, 2003)

Phillips's ROI framework incorporates techniques used to evaluate the effectiveness of training programs. His methodology estimates the impact of the training by obtaining information about the estimated performance improvement, that resulted from the training, directly from program participants. Then, have the senior management make adjustments to the estimates of the participants. Adjustments are essential since there are several factors that will affect performance data after training (J. J. Phillips, 2003). Phillips reports that the effectiveness of his methodology rests on the hypothesis that participants who receive training are capable of estimating and determining the magnitude of improvement that resulted from the actual training program. This information can be obtained by conducting questionnaires that are carefully crafted. Then, the computation of the qualitative aspects of ROI can be done. If the questions are orthogonal, a small number of respondents are needed to achieve statistical power.

2.5 Frost and Sullivan Model

Frost and Sullivan (2004) is one of the initial studies that applied ROI evaluation for a simulation-based training in healthcare. The study evaluated the ROI of three training simulators. The three simulators are CathSim Vascular AccuTouch System, Endoscopy AccuTouch System, and Laparoscopy AccuTouch System (w/LapSim modules) over a five months period (October 2003 – March 2004). The objective of the study was to build an interactive ROI calculation model using Monte Carlo simulations.

To identify the factors that contributed in the ROI determination, Frost and Sullivan conducted surveys and interviews to a sample of 237 individuals that included staff physicians, residency directors, nursing directors, nurses, risk managers, and CFOs or controllers in hospitals, Universities and Community Colleges across the United States.

The study also determined the Payback Period for each simulator. In addition to that, the study categorizes the contributing factors into the following four categories:

- Cost
- Financial Benefits
- Non-Financial Benefits, and
- Benefits to the Patient

Cost category considers the cost associated with the deployment and operation of the simulator including:

- Initial purchase price or leasing program cost
- Maintenance cost
- Cost of time to integrate the simulator into the training program, and
- Cost of the space the simulator occupies in the facility

Financial Benefits category included the factors:

- *Operating room or procedural time savings* – this factor is based on the proposition that practicing on a simulator advances techniques resulting in faster procedures with fewer errors, and as a result, providing the opportunity for additional procedures in the OR.
- *Instructor timesaving* – less personal instruction is needed because the trainees have learned independently of the simulator.
- *Reduction in errors that cause complications and cancelations* – fewer complications because residents are not practicing on a live person but in the simulator category.
- *Financial value for faster time to competence* – the proficiency required for the trainee to be considered productive can be achieved faster and, as such, adds larger financial benefit to the institution that employs them.

- *Reduction in equipment repair and spoilage cost* – learning handling techniques during the simulator training result in reduced equipment repair cost.
- *Reduction in alternative training cost* – these may include cadavers, mannequins or other models, animal labs or tissues.
- *Revenues from selling practice time on the simulator* – medical educational units are required for continued certification.

The non-financial category included the factors:

- *Recruiting* – potential recruits’ showed interest in the institution’s training equipment.
- *Evaluating trainees* – provides an objective assessment of trainees.
- *Credentialing new hires* – useful evaluation of the skills of potential new hires
- *Better quality of care* – useful staff training and educational efforts
- *Trainee satisfaction* – the majority of the trainees demonstrate a sense of achievement in developing their skills on a simulator prior to applying their techniques on patients.

The benefit to the Patient category included the factors:

- Reduction in the length of stay at the hospital
- Reduction in the after-procedure discomfort
- Shorter recovery periods, and
- Reduction in cost

2.6 Cost Savings from Reduced Catheter-Related Bloodstream Infection After Simulation-Based Education for Residents in a Medical Intensive Care Unit

Cohen et al. (2010) have investigated the ROI of a simulation-based training for central venous catheter (CVC) insertion in the Medical Intensive Care Unit (MICU) at an urban teaching hospital, Northwestern Memorial Hospital (NMH), an 897-bed tertiary-care hospital. The NMH MICU is a 20-bed facility that treats about 1500 patients per year.

Interventions to decrease avoidable complications such as catheter-related bloodstream infections (CRBSI) can also decrease hospital cost and increase the profitability. The purpose of this study was to estimate the cost savings for the hospital that associated with the reduction in CRBSI after simulation training for residents. The study shows that the CRBSI rates have dropped sharply following the completion of the simulation-based learning program in CVC insertion by residents. This study estimated the savings by comparing the CRBSI rates of the year after and before the training using case-control and regression analysis.

The findings of this study estimated that the training was able to avoid 9.95 CRBSIs among MICU patients with CVCs in the year after the training. The additional days to the length of stay in the hospital due to complications is about 14 days, which include 12 MICU days, and the incremental cost attributed to each CRBSI was about \$82,000 in 2008. By multiplying the avoided CRBSI cases by the cost of each CRBSI, the savings are about \$700,000.

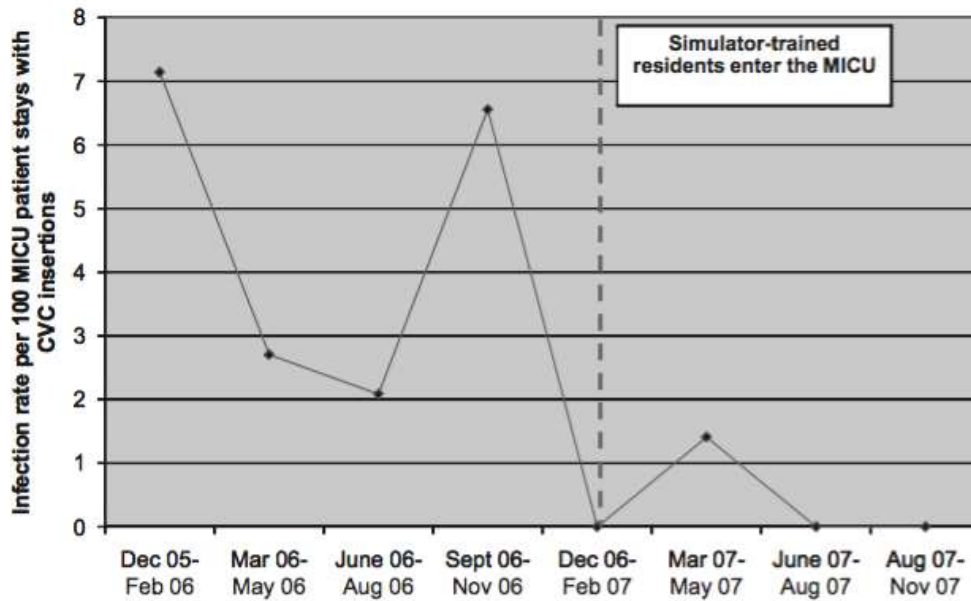

Figure 2-2: Quarterly catheter-related bloodstream infection (CRBSI) rates before and after a simulation-based educational intervention in the Medical Intensive Care Unit (MICU) (Cohen et al., 2010)

Table 2-1: Year 1 Simulation-Based Training Cost Adjusted to 2008 Dollars

Item	Units	Cost/Units	Total Cost
Ultrasound	1	\$19,475.07	\$19,475.07
Central line simulator	1	\$1,353.40	\$1,353.40
CVC kits	210	\$35.73	\$7,429.80
Simulator supplies	16	\$439.35	\$6,960.00
Ultrasound cover probes	90	\$14.10	\$1,256.40
Sterile gowns	150	\$2.98	\$442.50
Sterile drapes	15	\$50.08	\$743.70
Supply cart	1	\$1,633.20	\$1,633.20
Supplies total			\$39,294.07
<hr/>			
Other Expenses	h	Cost/h	Total Cost
Simulator facility rental	330	\$45.00	\$14,850.00
Instructor Salary			\$50,500.00
Research Assistant Salary			\$7,272.00
<hr/>			
Total cost			\$111,916.07

The annual approximated expenses of the simulation-based training were about \$112,000. Using the annual cost of the simulation-based training and the annual savings, the study approximated the ROI to be 7. This led to the conclusion that in the case of CVC insertion, the simulation-based training was highly cost-effective, and that the investment in this type of simulation-based training has a high ROI and has a significant cost reduction, which makes the decision-making process easier.

2.7 ROI of an Educational Module and Simulation Learning Experience to Improve Medication Safety

Durham (2014) studied the implementation of an Educational Module and Simulation Learning Experience to Improve Medication Safety. In the economics part of the study, Durham considered the adverse drug events (ADE) to estimate the cost saving and the ROI of the intervention. The reported incremental cost of an ADE range from \$2,000-\$9,000. Therefore, the considered average cost of an ADE is projected to be \$5,500 in additional cost per hospitalization. This amount does not include the medical professional liability (MPL), administrative cost, or lawsuit fees. A further cost of an ADE includes the extended length of stay, other medications, doctor visits. The average incremental annual cost for preventable ADEs was \$600,000 in payer cost, the average annual MPL cost associated with ADEs from injectable medications was \$72,000 per hospital, and legal settlement cost averaged \$376,500 per case (Lahue et al., 2012). Another cost of ADEs may include missed work, reduced quality of life or disability for the patient, pain, and suffering, and even death. The aggregated projected cost of savings related to avoiding one medical error secondary to a narcotic agent is \$487,690 (Durham, 2014). The cost of executing the module and simulation experience for nurses to improve their knowledge and understanding of

caring for patients with patient-controlled analgesia devices is found on the operating statement \$62,368. Therefore, the hospital would cover all the expenses of the program by avoiding one occurrence.

For ROI calculation, Durham estimated four expected occurrences per year to bring the total to \$1,928,760. The following is the ROI assumptions and calculation of the study:

- Annual cost for preventable ADE in payer cost = \$600,000
- If 50% of preventable ADEs are related to injectable medications, then annual cost = \$300,000
- Annual MPL cost from injectable medications = \$72,000
- Therefore, annual cost for ADE's related to injectable medications = \$372,000
- Multiple by 0.33% (probability of ADE being related to narcotics) = \$122,760 is the total annual cost for ADEs related to narcotics.
- Legal settlement cost = \$376,500 per case
- A conservative assumption of 4 occurrences/year, places the total cost of legal fees to \$1,506,000
- Add the legal fees to the annual cost for narcotic ADEs = \$1,628,760
- If indirect cost are included, we can add an additional conservative estimate of \$75,000 per event (\$300,000), for a grand total \$1,928,760

Return on Investment (ROI) = (Gain (Savings) \$1,628,760 – Cost \$62,368) / Cost \$62,368

ROI (Direct cost) = 25.12%

Return on Investment (ROI) = (Gain (Savings) \$1,928,760 – Cost \$62,368) / Cost \$62,368

ROI (Direct + Indirect Cost) = 29.9%

2.8 The Modified Approach Based on Kirkpatrick-Phillips Model

Pastrana, Rabelo, and Goldiez (2014) modified the approach to the qualitative component of training on ROI of Phillip's isolating effects of training program method. This accustomed method requires the Training Administrators and Medical Directors to use a range of values. This range includes conservative to optimistic values to approximate the enhancement and confidence levels for values reported from training participants. This modification is integrated with Phillips's approach which acquires estimations of the impact of the training directly from participants and has the Senior Management to decide the adjustments to participant's estimates. Phillips combines the value by multiplying the percentage estimates from the participants to that of Senior Management. In addition to that, this new approach offers the option to take a conservative approach that will choose the lower value between the two estimates.

This work endorses an altered approach to determine the combined values for qualitative estimations on improvement and confidence levels. This approach suggests calculating averages and standard deviations of the inputs from the qualitative questionnaires. The total number of participants will be identified by a statistical power analysis. If the desired statistical power is not

achieved or if the classification of data by experience and/or expertise is desired, additional questionnaires may be needed. Based on the outcomes, decision makers at healthcare facilities can select a conservative or optimistic variation of the Mean value and all decisions should be documented.

2.8.1 Methodology Implementation Steps

This section will introduce the steps of this modified approach that is based on Kirkpatrick-Phillips Model to compute ROI in medical simulation-based training programs and its components. The study has identified a number of parameters and has studied key methodologies to define an ROI methodological approach. In order to help healthcare facilities management, administrators, and medical personnel in moving forward to perform ROI computations, the study has identified the most appropriate parameters. Pastrana et al. (2014) used the Phillips ROI framework as a baseline for the definition of methodological steps and for the qualitative components analysis of ROI. Moreover, the information collected from the examples of medical training program ROI found in the literature and the interviews of medical practitioners at participating healthcare facilities involved in the methodological study produced both quantitative and qualitative ROI parameters.

The following are the methodological steps:

Step 1: Develop and review training program requirements:

The first step in this methodology is to develop quantitative cost parameters and quantitative benefit-cost parameters as part of the training program requirements.

The quantitative cost parameters proposed by this study include:

- System deployment or acquisition cost
- Maintenance expenses
- Training program administration expenses
- Cost of training personnel
- Facility cost (training rooms, OR usage, other specialized clinical or laboratory facilities)

Quantitative Benefit Cost Parameters include:

- Procedural time savings
- Instructional time savings
- Procedural complications cost
- Reduction in job injuries cost
- Procedural cancellation cost

This study considered a number of qualitative parameters as a training program requirements. These qualitative parameters are:

- Speed in diagnosis
- Speed in treatment (bedside)
- Speed in treatment (specialized room, such as ICU, OR, etc.)
- Reduction in treatment errors
- Reduction in diagnostic errors
- Improved patient and family communication-related interactions
- Speed in the introduction of new equipment
- Introduction of new clinical procedures
- Adjusting to or learning systems based practices specific to your VA MC
- Reduction in injuries (patient and caregiver)

Step 2: Develop evaluation plan and collect baseline data during training:

Training administrators and medical directors should plan how to gather and examine medical program activities and services that can be associated with the medical program cost related data in order to take it into consideration. Therefore, while training programs are taking place, administrators should collect data related to medical program activities and services linked to the baseline data representing training program requirements (e.g., Reduction in medical complications and reduction in job injuries).

Step 3: Collect data after program implementation:

This methodology adopts the questionnaire approach for obtaining improvement and confidence estimates from training participants and those providing training. The questionnaire is based on the qualitative parameters identified in Step 1 in the ROI methodology.

Step 4 & 5: Capture cost and benefits of SBT program:

The cost related to the medial simulator can be determined from the first step. This comprises the initial simulator acquiring cost, maintenance expenditures, cost related to simulator training facility and the cost of training medical personnel associated with a particular medical program. Care should be taken to compute the sum based on a documented NPV.

Qualitative parameters are very important in defining financial benefits and cost since they are related to the quantitative parameters specific to the medical program activities and services. These benefits embrace procedural/instructional time savings to the reduction of complication/canceled procedures. Consideration should be given to compute the sum based on a documented NPV.

Step 6: Isolate the effects of the training program:

The isolation of the effects of the training is based on the information collected after program implementation for the impact of training qualitative parameters from training participants in Step 3 with the consideration of the adjustment by the medical directors and training administrator.

Step 7: Compute the ROI:

The ROI is a simple computation that presents the relation between the financial benefit cost and quantitative cost for any expenditure. In this case, it will be about the implementation of a simulation-based medical training program. The following is the general formula for computing the ROI of any investment:

$$\text{ROI} = (\text{net program financial benefit cost} / \text{quantitative cost}) * 100$$

This approach is a modification of an existing ROI model for healthcare simulation and provides a customized approach in defining a qualitative and quantitative parameter for computing ROI. In addition to that, it considers other relevant, non-ROI parameters, in the decision-making process. The modified ROI approach for healthcare simulation-based training program investments integrates a customized methodology to the isolation of effects in training programs presented by Phillips.

2.9 Measuring ROI in Healthcare

J. Phillips, Phillips, Phillips, and Buzachero (2013) developed a guide for measuring ROI in healthcare improvements in general. This guide contains tools and techniques to measure the impact and ROI of healthcare improvement projects and programs. This guide is one of the initial efforts that aimed to systematically quantify and measure what was previously unmeasurable and convert this data into monetary values to be considered in the ROI calculation. This guide provides evaluation tools and techniques for measuring the ROI of healthcare improvement projects including technology implementations, system-wide procedures, and systems integration that ensure nurse retention, risk management, and leadership development.

This is a step-by-step guide to collecting, analyzing, and reporting data in a consistent manner explains how to:

- Align project's intended outcomes with organizational needs
- Collect and measure participant feedback
- Evaluate the application and implementation of projects
- Measure business impact and connect improvement directly to your efforts
- And, develop monetary values to calculate ROI

This methodology presented in this book is an approach to evaluate the effectiveness of improvement projects throughout the healthcare life cycle. The methodology focuses on projects' results to ensure that projects deliver value to the customer.

2.10 Summary of Literature

This literature review explored the research and the efforts that considered the application of simulation-based training and education in the healthcare sector. In addition to that, the consideration of tangible and intangible values in evaluating simulation investment was investigated. Moving through the literature review process, the different efforts and models that have been used to evaluate the ROI of simulation-based training in healthcare were discussed in details.

Simulation-based training has been an essential solution to fulfill the increasing demand of regulations toward patient safety, quality of care, and reducing errors (Issenberg, McGaghie, Hart, & et al., 1999). This led to a progressive adoption of the different simulation-based training and education forms including high- technology simulation, role-play, electronic or screen-based simulation, electronic human patient simulators, and audiovisual systems (Aldridge & Wanless, 2012; Clark, 2008; Issenberg et al., 1999).

The consideration and integration of intangible when evaluating the ROI of a simulation-based training in the medical field has been scarce. The vast majority of the work was for military-related simulation research to find the value of simulation to military training and has been based on cost reduction. Little has been published in the open literature about a rigorous methodology

that takes into consideration the different factors during the life cycle of a simulator and the context of the organization (Goldiez & Pastrana, 2013; Pastrana, Rabelo, & Goldiez, 2014).

One of the models that considered the integration of intangible value and qualitative aspects of training in general is the Kirkpatrick-Phillips Model. Phillips expanded on Dr. Kirkpatrick's Four Levels of Evaluation for measuring performance in Training and Human Performance Technology (HPT) programs by adding the “Fifth Level” of ROI Methodology for training and HPT programs. This model evaluates the business value to the organization based on a particular investment or project to determine a framework for gathering program data to support and improve established training and performance programs (J. J. Phillips, 1991, 1997). The following Figure 2-3 is a summary of Kirkpatrick-Phillips Model.

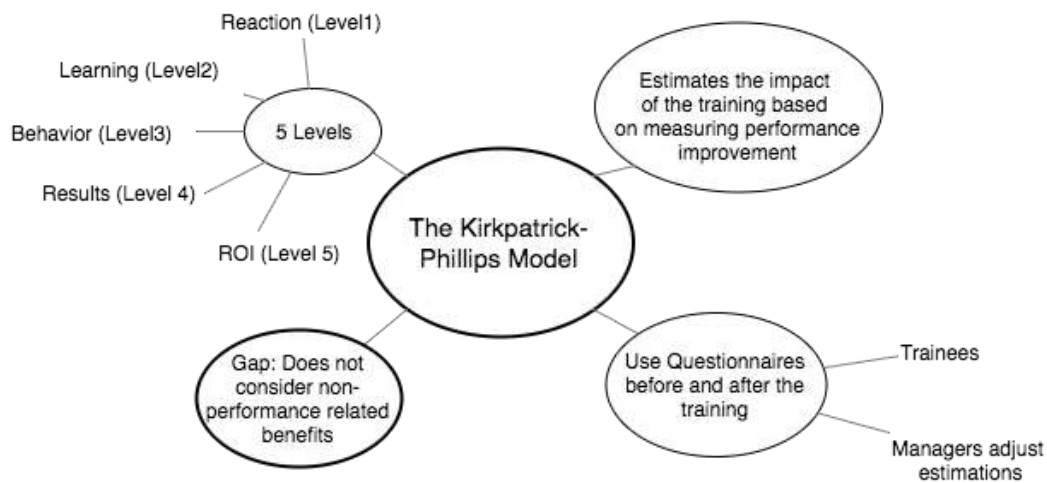

Figure 2-3: Summary of Kirkpatrick-Phillips Model

Frost and Sullivan is one of the initial studies that applied ROI evaluation for a simulation-based training in healthcare. The study evaluated the ROI of three training simulators: CathSim Vascular AccuTouch System, Endoscopy AccuTouch System, and Laparoscopy AccuTouch System (w/LapSim modules) over a five months period. The objective of the study was to build an interactive ROI calculation model using Monte Carlo simulations (Frost & Sullivan, 2004). The following

Figure 2-4 is a summary of Frost and Sullivan Model.

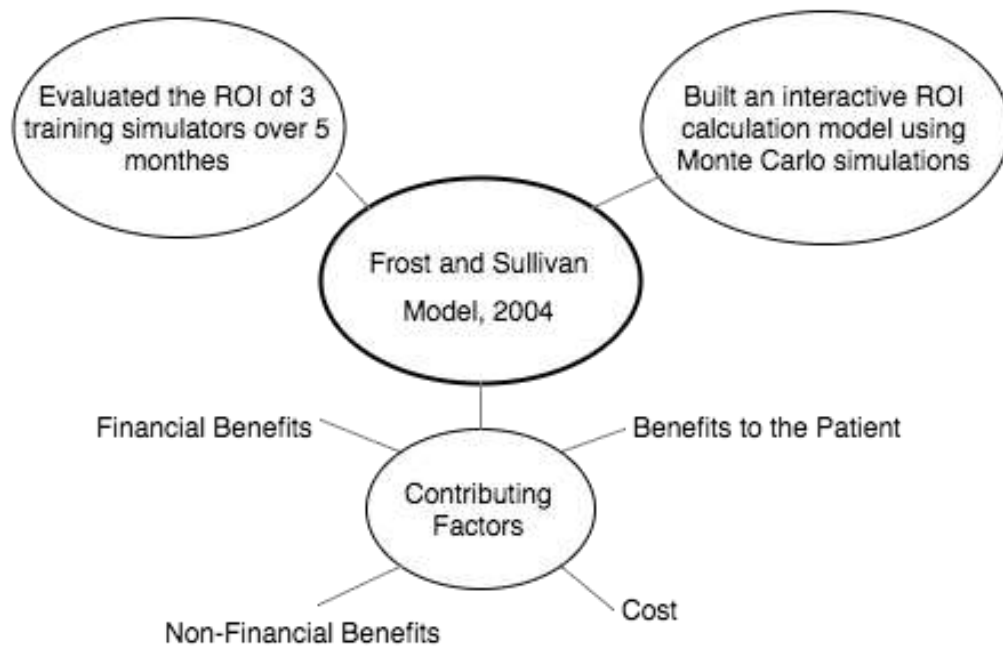

Figure 2-4: Summary of Frost and Sullivan Model

Pastrana et al. (2014) have combined part of Frost and Sullivan model with Phillips model after introducing some modifications to the approach of the qualitative component of training on ROI of the Phillips isolating effects of the training program. The following Figure 2-5: Summary of The Modified Approach Based on Kirkpatrick-Phillips Model.

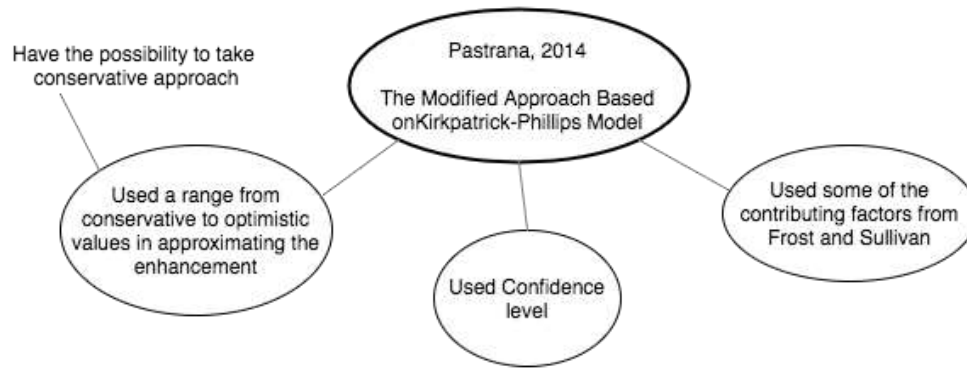

Figure 2-5: Summary of The Modified Approach Based on Kirkpatrick-Phillips Model

J. Phillips, Phillips, Phillips, and Buzachero (2013) developed a guide for measuring ROI in healthcare improvements in general. This guide contains tools and techniques to measure the impact and ROI in Healthcare improvement projects and programs by systematically quantify and measure what was previously unmeasurable and convert this data into monetary values. This is applicable to measuring the ROI of healthcare improvement projects including technology implementations, system-wide procedures, and systems integration that ensure nurse retention, risk management, and leadership development. The following Figure 2-5: Summary of The Modified Approach Based on Kirkpatrick-Phillips Model.

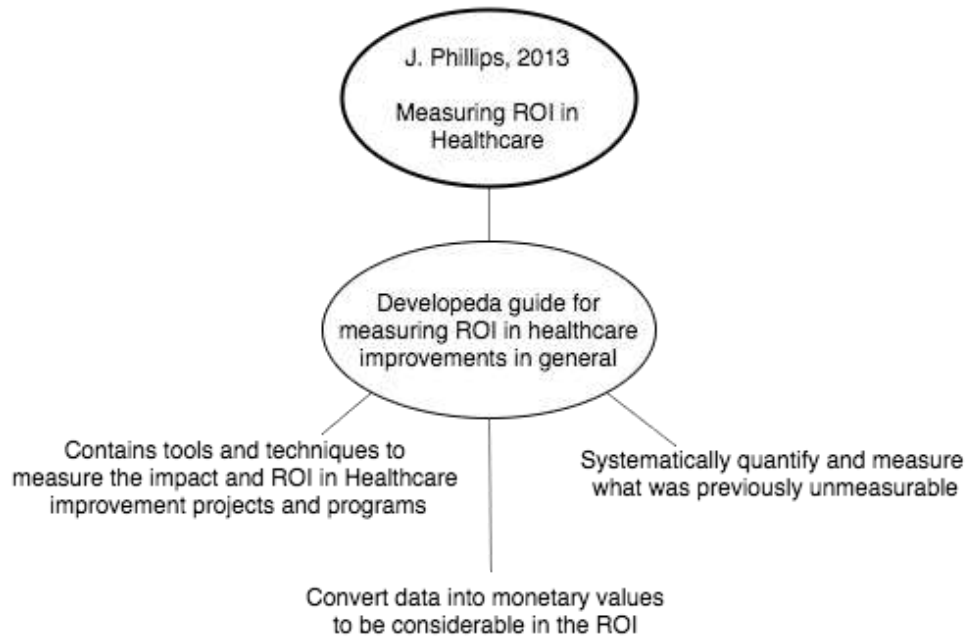

Figure 2-6: Summary of Measuring ROI in Healthcare Improvements Guide

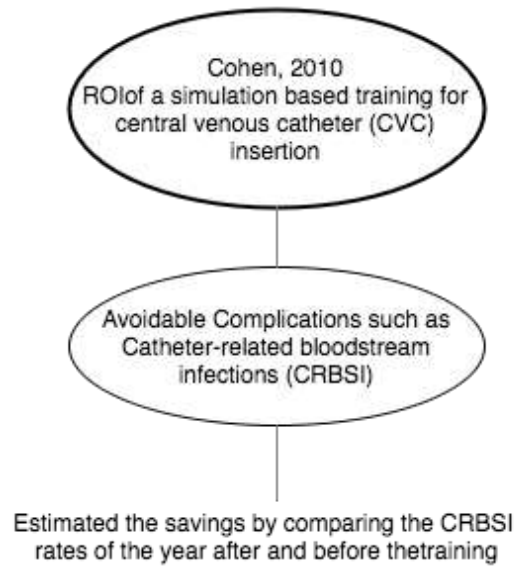

Figure 2-7: Summary of Cohen, 2010 Paper

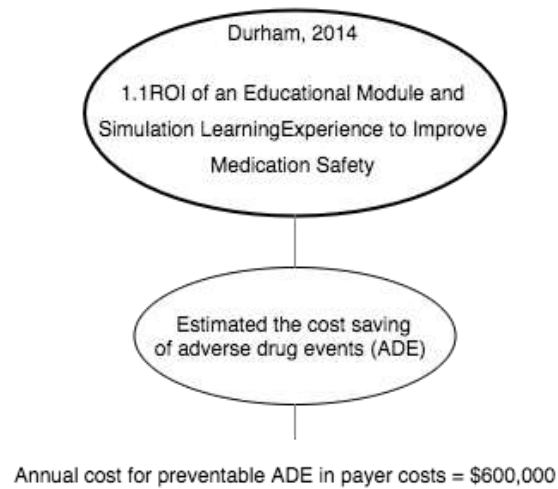

Figure 2-8: Summary of Durham, 2014 Paper

2.11 Gap Analysis

Throughout the review of the literature, we were not able to identify a framework that enables a determining the ROI with a systematic approach that facilitate the identification of the key tangible and intangible benefits of a particular healthcare simulation-based training from multiple perspectives and then, integrate these benefits in ROI calculation.

The literature review showed three components that must be considered in determining the value of simulation; quantitative, qualitative, and cost. But, the review did not show a framework or methodology that facilitate the identification of key contributing factors to be considered for a specific simulation-based training intervention.

A framework that facilitates key contributing factors identification process of tangible, intangible, and cost can be a valuable contribution. In addition to that, integrating these three factors, together and quantifying the qualitative factors in a systematic fashion gives decision makers a better perception of the value simulation offers. Although techniques for determining each component exist, we couldn't find an integrated approach that put all these important components together for simulation-based training in healthcare.

The Figure 2-9 below summarizes the existing models and depict the gaps in each model to identify the common gaps in the literature and develop a framework that can fill these gaps and benefits from the existing models.

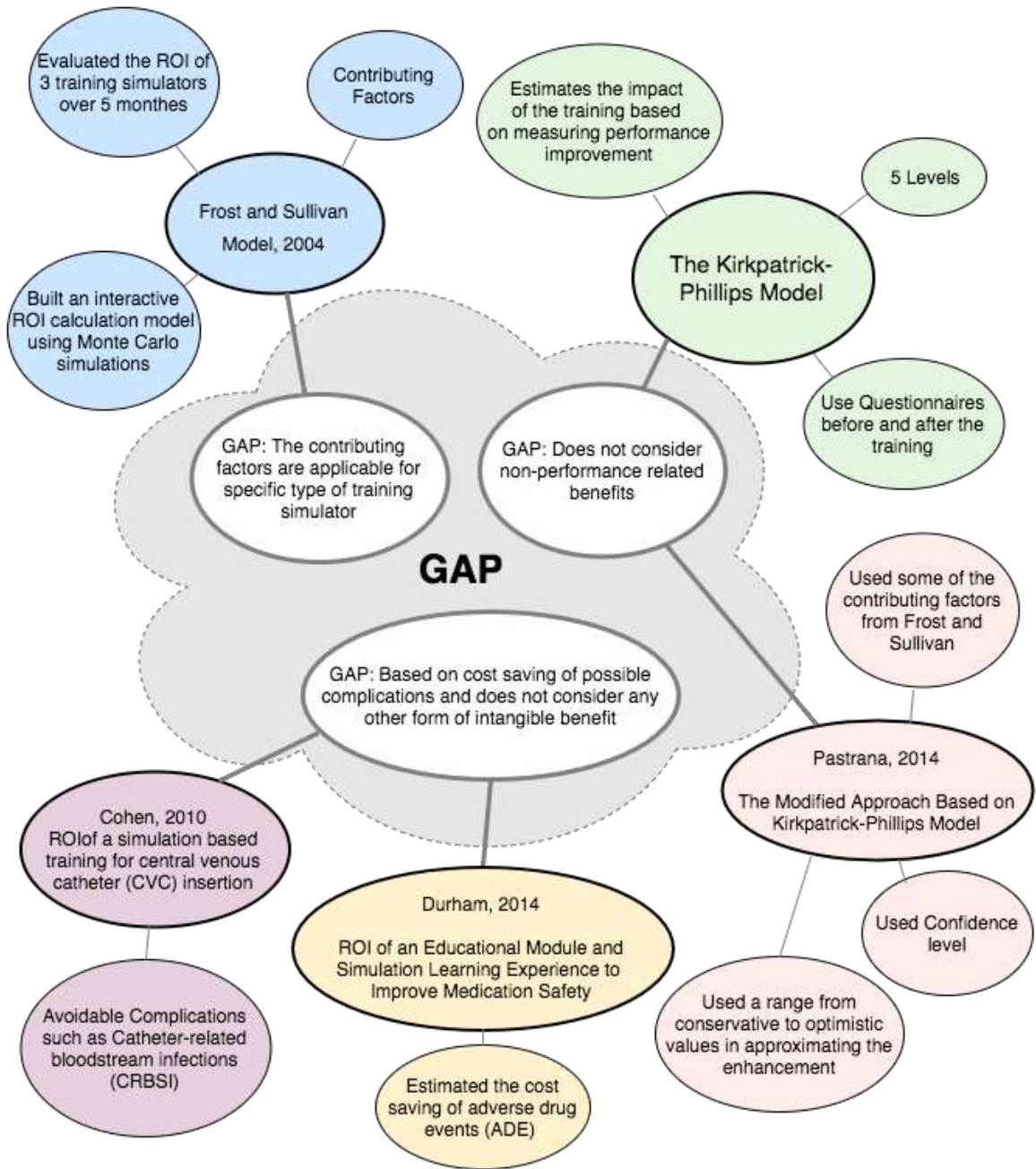

Figure 2-9: Summary of Existing Models and Gaps in Each Model

CHAPTER 3: METHODOLOGY

This chapter presents the research methodology applied to articulate an organized study on the problem of measuring the ROI of simulation-based training in healthcare. A research methodology is a systematic approach to analysis applied to the field of study. It, in fact, sets the structure of the development of a dissertation which will provide new information and new ideas towards its relevant field. Developing a dissertation requires identifying a new problem thorough literature review, and then developing a solution. The research methodology encompasses the phases that make up how to progress and proceed from identifying the problem to eventually formulating a solution.

3.1 Research Methodology

The Figure 3-1 below illustrates the research process followed in this study. It is a way to depict how the train of thought progressed as we moved forward in this dissertation. The rest of this chapter will give an overview of each process and its tools and techniques. The processes in the diagram include the development of the research idea, literature review, the identification of the research gap and the tools used in this process, framework development, validating the framework through case study and analyzing its results, concluding the study, and future work.

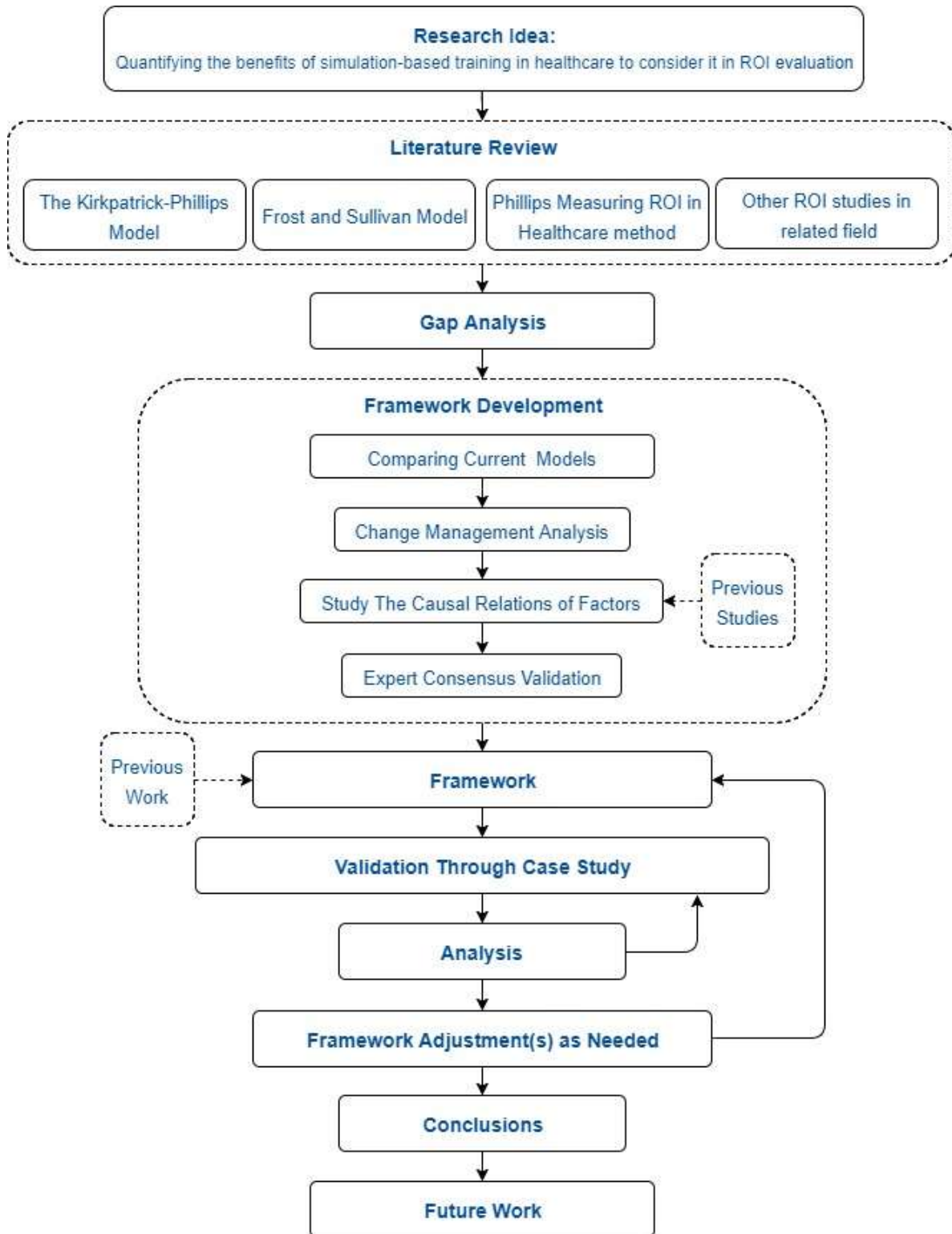

Figure 3-1: Research Methodology Diagram

3.2 Research Idea

The research idea initiated from a study that was conducted by The Institute for Simulation and Training (IST) at the University of Central Florida (UCF) in a partnership with the U.S. Veterans Health Administration (VHA) to identify key parameters and methodologies for computing a Return on Investment on the benefits of using simulation for healthcare training, education activities and/or programs in the VHA system. Then, it evolved while exploring the available tools to identify the ROI for simulation-based training. It was recognized that most of the work to find the value of simulation to military training had been organized around cost avoidance. Little has been published in the open literature about a rigorous methodology that takes into consideration the different factors during the life cycle of a simulator and the context of the organization.

3.3 Literature Review

The next logical step was to carefully review the literature to learn from and build on the existing knowledge. To develop a solid background in the area of research, the review started with investigating the adoption of simulation-based training and education in the healthcare field. Then, the literature review explored the existing models that have been used to evaluate the ROI of different simulation-based interventions in order to study the methodologies and the components that have been considered to build and implement these models. The review of the literature of these areas is very crucial to help in identifying the gap.

3.4 Gap Analysis

This is essential to identify and recognize the gap in the literature in order to form a solution that contributes to solving the defined problem and bridging that gap. This will require more investigation of existing models. In addition to that, comparing current models and studying the relationships between factors is important at this stage and for the next one.

Throughout the review of the literature revealed the absence of a framework that enables the determination of the ROI in a methodical approach that enables the identification of the key tangible and intangible benefits of a particular healthcare simulation-based training from multiple perspectives and then, integrates these benefits in ROI calculation.

3.5 Framework Development

3.5.1 Comparing Current Models

Understanding the existing models in depth is very important at this stage. One way to do that is comparing the models. For deeper understanding and comparison, the strengths and weaknesses of each existing model will be identified and analyzed. This analysis of weaknesses in the existing models is critical for framework development as overcoming these weaknesses should be taken into consideration. In addition to that, understanding the strengths and weaknesses is essential to benefit from strengths to develop an improved or even new framework that overcomes the weaknesses. The comparison will be made by using different parameters to assess strengths and weaknesses.

3.5.2 Study the Causal Relations of Factors

Now, from the previous, we can see the most important variables and key factors and we need to study the relationships between these variables and key factors. Then, we can create a solid structure for the structure of cost and benefits for our framework. One way to study the relationships between the factors that contribute to ROI calculations is to analyze it as a system and use system thinking. System thinking is a method that observes the complex system, which contains system components or system of systems, in order to understand the system and the interrelations between components holistically and comprehensively. System thinking is appropriate for understanding healthcare complicated systems and the interrelations between its various elements (Faezipour & Ferreira, 2013b).

System dynamics is a modeling technique that is useful to model, study, and manage complex systems. It establishes the structure of the system by identifying the different variables of the system and their relationships. This system structure serves as a base for the model that is simulated to identify the leverage points of the system. The system dynamics model consists of stocks, flows, time delays, variables, and feedback loops and represents a system or part of a system. The stocks are symbolized by rectangles while the flows are symbolized by arrows pointing in and out of the stocks representing inflows and outflows, respectively. The valves on the arrows control the magnitude of the flows in and out the stocks. The source and sink are symbolized by a cloud symbol. The source has an arrow coming out, while the sink has an arrow going into the cloud (Reddi & Moon, 2011). The following Figure 3-2 show the notations of components in system dynamics simulation model.

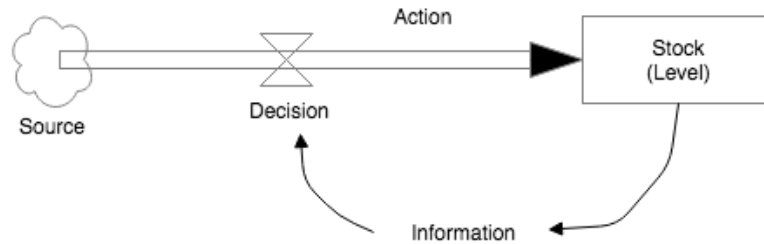

Figure 3-2 Notations of components in system dynamics simulation model

One of the important tools that support the system dynamics is causal loop diagram. Causal loop diagrams are basically mental maps of the system or problem of interest. They are a visual representation of the system's components, factors, and relations. It consists of system variables linked together via linear cause and effect connections. The relation between factors and components of the system is represented by links that have a + or – sign to reflect the increasing or decreasing relation between factors (Faezipour & Ferreira, 2013b). The following Figure 3-3: Example of Causal Loop: Patient Satisfaction Sustainability Causal Model. Adopted **from Faezipour and Ferreira (2013a)**

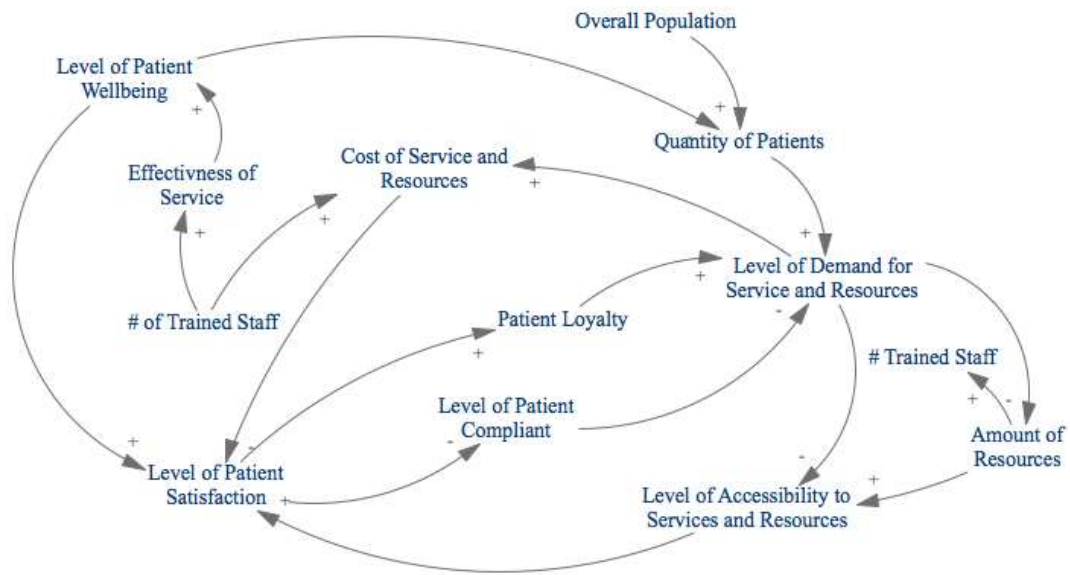

Figure 3-3: Example of Causal Loop: Patient Satisfaction Sustainability Causal Model. Adopted from Faezipour and Ferreira (2013a)

Developing causal loop that represents the relationships between factors will clarify the structure of cost and benefits that contribute to the ROI framework. Causal loops help to visualize the relationships and the effects of the factors on the entire system. This will support the validation process of the relationships. The validation of the causal loops will be done by the consensus of experts in the field.

3.5.4 Consensus Validation

The step follows the development of the causal loops that represent the relationships between variables is the validation of these causal loops. The proposed validation research method is experts' consensus. Important professionals in the related field will be asked to analyze and validate the causal loops before incorporating them in the development of the framework.

When published information is insufficient or non-existent, consensus methods allow a wider range of qualitative assessment. These methods offer the ability to harness the insights of appropriate experts to enable decisions to be made about certain issues. For example, Delphi technique, one of the consensus methods, has been widely used in healthcare research within the fields of technology assessment, education, and training. The other consensus technique is the nominal group technique. It is, also, commonly used in healthcare in the context of examining the appropriateness of clinical interventions, education, training, practice development, and identifying measures for clinical experiments (Jones & Hunter, 1995).

3.6 Framework

Once the gap is identified, strengths and weaknesses of existing models are identified, now we can put the pieces together to develop a preliminary framework that can build on and benefit from the strengths of the existing models and overcome the weaknesses to evaluate the ROI of simulation-based training in healthcare. Because of the multi-dimensional nature of cost and benefits of simulation-based training, we will need a solid criterion to facilitate the identification of this multi-dimensional cost and benefits in the framework. In addition to considering factors

existing models and case studies, we will consider a methodology called Value Measurement Methodology (VMM).

However, in our previous research, we found a methodology, the VMM, that has been developed and used by the Federal Government to define, capture, and measure value associated with electronic services unaccounted for in traditional Return on Investment calculations, to fully account for cost, and to identify and consider risk.

In July 2001, the Social Security Administration (SSA) and the General Services Administration (GSA) allied with a team of thought leaders associated with Harvard University's Kennedy School of Government and Booz Allen analysts developed a measuring methodology to measure the value of electronic services. (i.e., quantitative and qualitative values) that would stand by current federal regulations and under the Office of Management and Budget (OMB) guidance, which is applicable to the federal government. Later in 2002, the "How-To-Guide and VMM Highlights" document was released. The methodology allows for a decision framework (US Federal CIO Council, 2002) to be personalized and adapted to the specific requirements of a project. Through the applications of VMM process, the value of alternatives to a program is articulated and the risk lowered for the considered investment.

The VMM helps strategists in the Government to consider both tangible and intangible values when making investment decisions and monitoring benefits. Value is derived from the benefits generated directly to users, society and other stakeholders. The VMM value categories that could be applicable for healthcare simulation are: direct, social, operational, strategic, and financial (Pastrana et al., 2014; US Federal CIO Council, 2002).

One of the important applications of the VMM methodology in the determination of ROI for simulation-based medical training is considering the value categories of the VMM to identify the tangible and intangible benefits and cost simulation-based medical training. This questionnaire should help in identifying and prioritizing the key value and cost factors that need to be included in the ROI calculation. Then, the role of Phillips' methodology comes to play to quantify the qualitative key factors.

For example, Paige et al. (2007) studied the impact of simulation-based interdisciplinary operative team training. All of the participants completed a questionnaire after the training and the majority of them reported that the training would change their practices in the operating room. In addition to that, the training promoted team communication skills, crisis-related teamwork and improved recognizing operating room errors. All these are forms of operational values that can be captured using the VMM since the operational value is one of the value categories of the methodology. The study was concluded by this qualitative outputs. These outputs require transformation to monetary value and that is when Phillips ROI methodology is applied to quantify the monetary value of this operational improvement. Then it can be considered in the calculation of ROI.

In order to get feedback about the framework, and as part of the research efforts, the framework will be presented at various industry conferences and submitted to professional journals in the field.

3.7 Validation Through Case Study

The validation process will be done through a case study. The case study will follow the steps of the proposed framework to test its validity. Lessons learned from the case study will be used not only to test the research hypothesis but also to make refinements in the preliminary framework.

Choosing the proper research method among the five major research methods: experiments, surveys, archival analysis, histories, and case studies is an important step in the research endeavor. The type of research questions, the focus on contemporary events, and the extent of control over the behavioral events are important factors the govern and selection of the suitable research method. There are some situations where more than one method is equally attractive, and in other situations, multiple methods are applicable. For example, case study within a survey, or a survey within a case study. There, also, situations when a particular method has a distinct advantage over other methods (Yin, 2013).

There are several definitions of case studies. Some definitions only repeated the topics that case studies have been applied to. For instance, according to Schramm (1971), the central tendency of all types of case studies is to study a decision or a set of decisions in order to justify, or describe the implementation and the outcomes and consequences of these decisions. This narrow definition does not present a comprehensive definition for a case study as a research method.

Yin (2013) more comprehensively defined case study research as “an empirical inquiry that investigates a contemporary phenomenon in depth within its real-world context, especially when the boundaries between the phenomenon and the context may not be clearly evident.” In order to help distinguishing phenomenon and context in real-world situations, Yin also described

important characteristics and features. For example, case study copes with the situations that have many more variables of interests than data points. That would lead to relying on multiple sources of evidence with data that require convergence in triangulating fashion. The case study also benefits from the prior development of theoretical propositions to guide data collection and analysis.

Even though case study research has been recognized as a qualitative research method, it is not limited to only qualitative studies, it has the capability to deal with both types of research qualitative and quantitative research (Creswell, 2013). In addition to that, case study research is an effective evaluation methodology. One of the most important evaluation applications is explaining the causal links in the real world interventions. Moreover, case study research is useful in situations when the being evaluated situation has no clear or single set of outcomes (Yin, 2013).

3.8 Analysis

The outcomes of the case study will be analyzed and processed in order to be interpreted as useful information. If the analysis revealed a need for adjustment and modification to the framework, then, the framework will be adjusted accordingly.

3.9 Conclusion and Future Work

This section will comprise a summary of the findings and final conclusions and recommendations based on the framework. Future work section will state the opportunities for further research in the area.

CHAPTER 4: FRAMEWORK DEVELOPMENT

4.1 Introduction

To develop an effective solution, it is important to understand and take in consideration the characteristics of the problem being solved. Understanding the characteristics is the essential guide to identify the tools, techniques, and methodologies that can be put together to construct the framework. Therefore, part of this chapter will explore the characteristics of the return on investment in simulation-based training in healthcare to lay out the roadmap of the framework development.

In addition to that, in order to develop the framework, it is essential to understand the existing models comprehensively. One way to do that, is to compare the models. This comparison can be made by identifying and analyzing the strengths and weaknesses of each existing model. Analyzing the weaknesses of the current models is important for the development of the framework as overcoming these weaknesses should be taken into consideration. Additionally, understanding the strengths and weaknesses is essential to benefit from strengths to develop an improved solution that overcomes the weaknesses. The comparison will be made by using different factors to assess strengths and weaknesses.

The next step in developing the framework is the change management analysis. The objective of change management is to assess the transformation from the current state to the future state of the process, and the time delays associated with the change. This will provide the nature of the relationships of the existing practices and the future practices that were developed as a result of the simulation-based training that took place and how the transition takes place. The Matrix of

Change is the tool that we will use for change management analysis.

The next step that we need to create a solid structure for the structure of cost and benefits for our framework is to study the relationships between the most important variable and key factors. System thinking will be used to identify and study the contributing factors and the relationships between the most critical factors. System dynamics and the causal loop is the system thinking tool that will be used to study the relationships. Causal loops help to visualize the relationships and the influence of the factors on the whole system. Since published information in this area is insufficient, the consensus of experts in the field will validate the causal loops.

Then the framework can be built based on the analysis of these causal loops, the strengths of the existing models, filling the gaps of the existing models, and incorporating other helpful and related tools.

4.2 Characteristics of Investments in Simulation-based Training in Healthcare

Change and uncertainty are ever-present features of the business world (Powell & Baker, 2009). The reason behind that is the nature of the market that is affected by multiple factors that are impossible to fully control or exactly and precisely identify. Therefore, the effective model should always involve planning for an uncertain future and must have tools for dealing with these aspects of the business.

The other characteristics of an investment, including investment in simulation-based training in healthcare, is the irreversibility and adjustment cost of investment, and economic uncertainty and complexity. These characteristics have negatively impacted investments as some

organizations prefer to avoid taking action and prefer to “wait and see” in uncertain circumstances (Bernanke, 1980). This is known as the option value of waiting. However, some theories suggest the possibility of uncertainty and investment having a positive relationship (Abel, Dixit, Eberly, & Pindyck, 1996).

Uncertainty and complexity are major features of investment in general. Dealing with this fundamental aspect of business requires considering the different possible scenario of all the contributing factors. Monte Carlo simulation is an effective technique that can deal with situations that have different possible scenarios. It is very useful for situations in which uncertainty is a key factor (Powell & Baker, 2009). Therefore, Monte Carlo simulation will be considered as part of the solution being developed and will be discussed in further sections of this chapter.

“The traditionally discounted cash flows (DCF) methodologies for investment evaluation, such as net present value (NPV) consider one scenario, but uncertainty implies different possible scenarios. Ignoring the favorable scenarios or disregarding unfavorable ones in the analysis could be misleading for decision makers” (Kodukula, 2006). Therefore, the solution should take into consideration the options embedded in the investment over its life cycle. Real Options is the scheme that can evaluate the investment taking into consideration the possible scenarios (Kodukula, 2006). Thus, Real Options analysis will be discussed in further sections of this chapter.

The other major characteristic of this type of investment is the qualitative nature of the outcomes and benefits in addition to the quantitative ones. Qualitative benefits are the benefits that are hard to measure and transfer into monetary value. Examples of qualitative benefits include the improvement of patient safety, quality of care, employee satisfaction, the reputation of the organization, and others. For the framework to be effective, it has to have a systematic approach

to quantify and monetize the qualitative and quantitative benefits in addition to the different forms of cost.

The importance of the finding the monetary value of qualitative benefits is that it demonstrates a tremendous portion of the benefit that could have a substantial impact on the ROI analysis and as a result, on the decision-making process. There are multiple tools that can be integrated together for this purpose. Among the tools that will be discussed in further sections in this chapter are the Value Measurement Methodology (VMM), Frost and Sullivan model, and Dr. Jack Phillips approach in measuring the ROI in health care. These different methodologies are among the initial efforts in this field (Bukhari, Andreatta, Goldiez, & Rabelo, 2017) and will be the building blocks of the monetary value analysis and cost and benefits structure part of the framework.

After the development of the monetary value analysis and cost and benefits structure part of the framework, a case study will be presented to demonstrate the application of this part of the framework and to examine the need of further analysis for that incorporate the uncertainty and the options in the analysis.

One more major characteristic that needs to be taken into consideration; it is the wide range of applications of the simulation-based training in the healthcare field. The use of simulation in healthcare for training is being adopted increasingly. This implementation is not restricted to technical skills and patient management, but its use has been extended to include the competencies of patient safety and teamwork (Dunn, 2004). This produced a diversity of forms and types of simulation that have been implemented in medical training. It is crucial to identify these types as different forms will have different cost and benefits structure. Therefore, a taxonomy that can

classify and layout the major categories and the diver's applications of this type of training is important to be part of this research.

4.3 Simulation-based Healthcare Training Taxonomy

The use of simulation in healthcare for teaching and training is being adopted progressively. This adoption is not limited to technical skills and patient management, but its use has been extended to encompass the competencies patient safety and teamwork (Dunn, 2004). This resulted in a variety of forms and types of simulation that have been implemented in medical training. It is crucial to identify these types as different forms will have different cost and benefits structure.

Before moving forward with the taxonomy, it is important to clearly define healthcare simulation. According to Chiniara et al. (2013) "Healthcare Simulation is an instructional medium used for education, assessment, and research, which includes several modalities that have in common the reproduction of certain characteristics of clinical reality". The experiential learning nature of simulation-based training requires the simulation to allow participants to interact and influence the outcomes of the experience. This brings us to the "immersive learning environment", a commonly used concept in simulation-based training. Immersive learning environment refers to any situation that is highly interactive and engaging them in a way that the participant's disbelief is suspended and the participant becomes active in the experience.

This part of the dissertation will present a taxonomy for the simulation in healthcare in. the importance of this taxonomy as part of the ROI framework comes from the wide variety and the

extended range of simulation forms, options, types, and application in healthcare education and training. This diversity of forms, options, types, and application implicate variation in the cost and benefits structure, which are the major contributors to the ROI evaluation. It basically important to identify what exact category and type of simulation the framework is being applied to.

4.3.1 Taxonomy Methodology

The categorization and classification of simulation-based training in healthcare will be done in two phases, primary and secondary. The primary phase will consider the main media category used to deliver the training. This will take into consideration the tools, the setup of the environment of the simulation, and the nature of interaction that is needed for the training. The secondary categorization will narrow it down to more specific categories further from the primary categories. It is important to point out that in many training situations in reality, a mixed and hybrid mode of several categories and types of simulations is required to deliver the required competencies. This classification will not take the level of fidelity of the simulation into consideration, because both options of Hi fidelity and Low fidelity is applicable for almost every category.

4.3.2 Primary Categorization and Classification of Simulations Used in Healthcare Training

Primarily based on the tools, setup of the environment, and the nature of the interaction, simulation can be categorized into four categories: computer-based simulation, simulated patients, simulated clinical immersion, and procedural simulation.

Computer-based simulation, the first category, allows the participant to interact with the simulation using screen-based interface. This category can be used for a variety of competencies. In some cases, it is used individually, and in other cases it can be integrated within a system in a larger environment in a hybrid mode (Chiniara et al., 2013).

The second primary category is simulated patients. This type of simulation has been in use for medical education and training for more than three decades (Barrows, 1993). Since medical care is largely depending on interacting with patients, patient simulation has become an effective way to replicate real patient encounters and essential form of training (Cleland, Abe, & Rethans, 2009). The simulated patient can be actual patient or an actor playing the role of an actual patient. This form of simulation is useful for elements of history taking, physical examination, and clinical reasoning (Barrows, 1993).

The third category is simulated clinical immersion. In this category, the participant is exposed to a reproduced environment that is exactly similar to the actual environment. The environment plays an important role in the educational experience and the sequence of events and as a result of achieving the required learning outcomes. Therefore, the concept of environment in simulated clinical immersion category should include physical setting, equipment, teammates, and other individuals involved in reproducing the desired situation. The environment can be real, in an actual clinical setting, or can be simulated. The scale can be small, a single operating room for example or can be large, building, battlefield, or a city for example. Simulating Emergency Department is one of the best examples of simulated clinical immersion that teaches crisis management in complex clinical settings (Chiniara et al., 2013).

Procedural simulation is the fourth primary category. Procedural simulation emphasizes on obtaining and improving procedures and technical skills. It allows the participant to replicate specific behaviors and tasks similar to the ones in the real-life. It also allows the participant to train in the specific sequence of tasks that are required to properly perform a specific technical skill (Chiniara et al., 2013).

In many situations, multiple outcomes can be accomplished by using different simulation categories at the same time, which can be described as a hybrid. The following Figure 4-1 represent the different primary categories and how can they merged together in a hybrid mode.

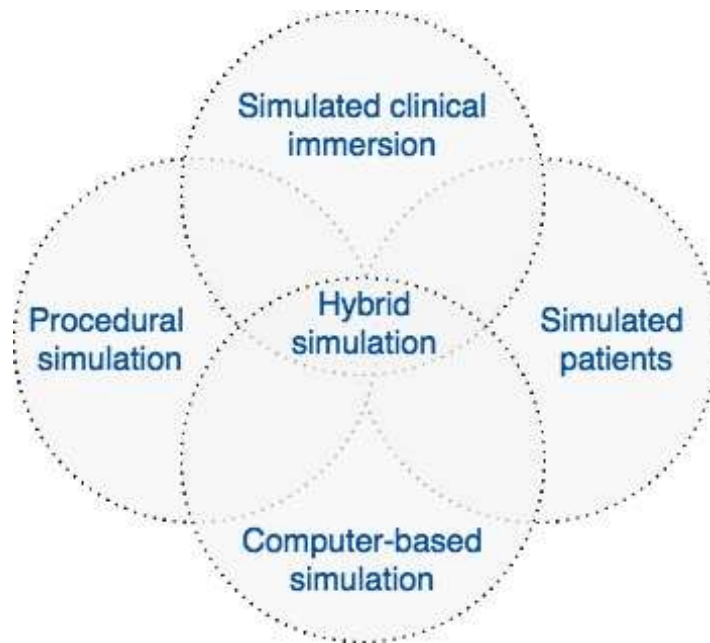

Figure 4-1: Primary Categories of Simulation-based Training in Healthcare

4.3.3 Secondary Categorization and Classification of Simulations Used in Healthcare Training

The secondary categorization is an extension of the primary categorization. It classifies each primary category into more specific types. For example, the simulated patient can be further classified into an actual patient who is willing to participate in the simulation, an actor who played the role of a patient, or a patient simulator like a life-size mannequin representing a patient, which can simulate several behaviors and characteristics of an actual patient.

An actor is a person who takes on a certain role during a simulation session. The actor can be a paid individual, a partner, or another participant. In addition to patient history taking and other skills and competencies that are related directly to the interaction with patients, this type of simulation can be used to develop several other skills. For example, an individual can play the role of a family member during a simulation session on communication skills.

Part-task trainer is an artificial simulator that replicates particular components of a patient or a system, for skills training. Examples of part-task trainers are TraumaMan System shown in Figure 4-2 (Simulab Corporation) and advanced Catheterization Trainer (Limbs & Things)



Figure 4-2: Example of TraumaMan System

The patient simulator is a life-size mannequin representing a patient, which can simulate several behaviors and characteristics of an actual patient. Examples of patient simulators include iStan shown in Figure 4-3 (CAE Healthcare), SimMan 3G (Laerdal Medical), and Noelle (Gaumard Scientific)



Figure 4-3: iStan is a wireless patient simulator with fully articulated movement and advanced features

The computer or web application is an example of a secondary category of computer-based simulation. It can be delivered either locally or through the Internet, that reproduces, in whole or in part, actual systems or equipment.

The virtual patient is another secondary category of computer-based simulation. It allows the participant to interact through a screen-based interface with a pre-programmed patient.

The virtual world can be categorized as a computer-based simulation and it can be integrated with simulated clinical immersion. It allows the participant to be immersed, through a screen-based interface in the digital recreation of an environment or setting. The participant often

interacts with the simulation through a digital persona, or “avatar”. Examples include Second Life (Linden Lab), Massively Multiplayer Online Games (MMOG).

Virtual reality simulators are also used for skills training. It provides the participant with the more realistic interface and outputs the results through a computer. Examples include Virtual I.V.TM (Laerdal Medical) and LAP MentorTM (Symbionix).

Using animals, human cadavers, and organic tissue are also considered as a form of simulation. It is a form of procedural simulator that uses organic material for skills training.

Performing a play and mocking codes is another form of hybrid simulation that combines simulated clinical immersion and simulated patients and could also involve other primary categories. It is one of the most effective forms of simulation for emergency departments. It has been used and proved its significant contribution to improving residents’ confidence in performing resuscitation, and as a result, patient outcomes of pediatric patient cardiopulmonary arrest (CPA) survival rates at the University of Michigan tertiary care academic medical center (Andreatta, Saxton, Thompson, & Annich, 2011)

The following Figure 4-4 Primary and Secondary Categories of Simulation-based Training in Healthcare

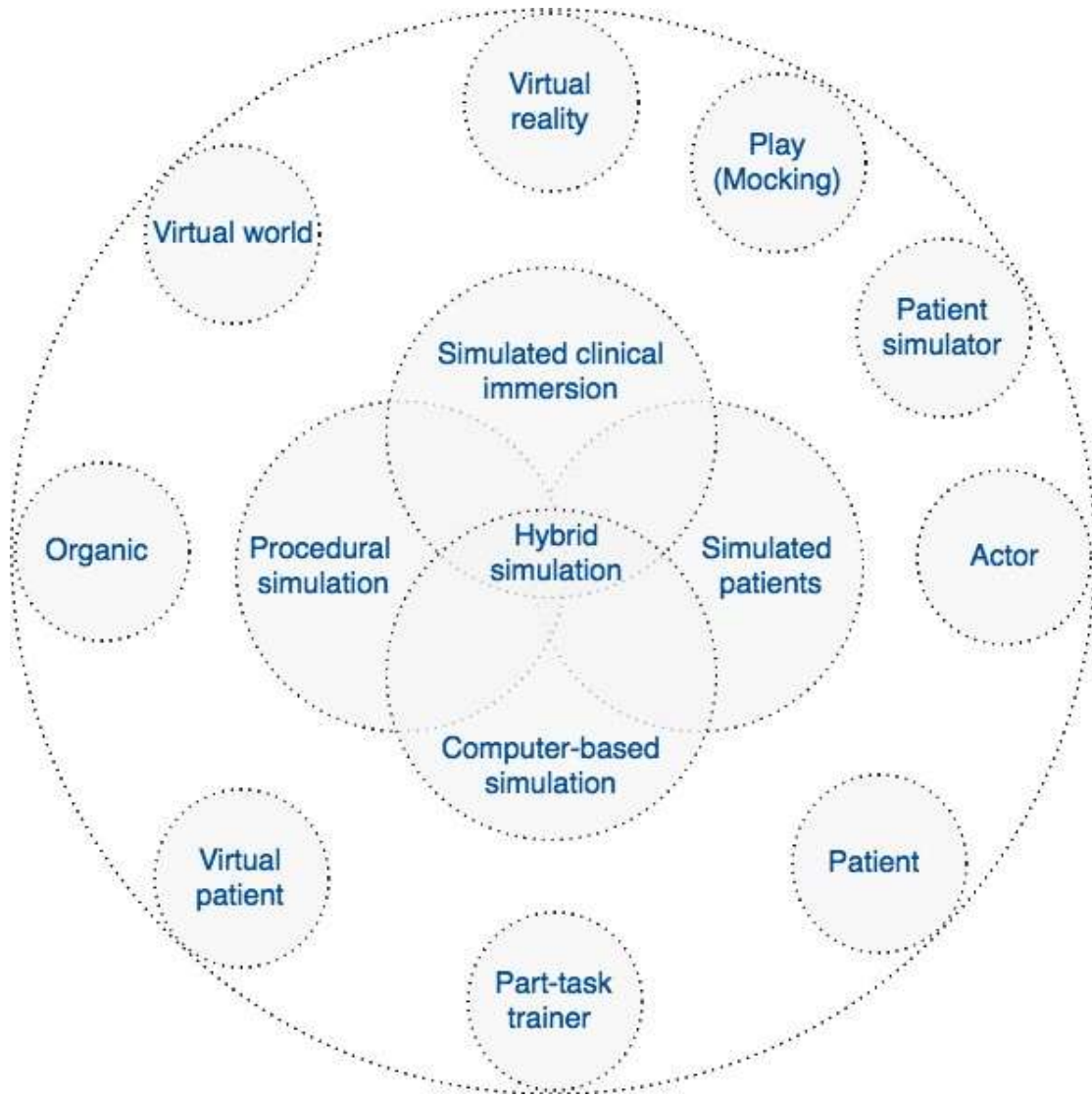

Figure 4-4 Primary and Secondary Categories of Simulation-based Training in Healthcare

4.3.4 Taxonomy Validation

The proposed validation method is experts' consensus. Important professionals in the related field will be asked to analyze and validate the taxonomy. When published information is insufficient or non-existent, consensus methods allow a wider range of qualitative assessment. These methods offer the ability to harness the insights of appropriate experts to enable decisions to be made about certain issues. For example, Delphi technique, one of the consensus methods, has been widely used in healthcare research within the fields of technology assessment, education, and training. The other consensus technique is the nominal group technique. It is, also, commonly used in healthcare in the context of examining the appropriateness of clinical interventions, education, training, practice development, and identifying measures for clinical experiments (Jones & Hunter, 1995).

To perform the experts' consensus, several healthcare experts were contacted. These experts were selected based on their experience in the healthcare field and their knowledge and experience in simulation-based training in healthcare. After that, three healthcare experts were contacted and the purpose and main idea of the validation have been introduced to them. Then the document that contains the simulation-based taxonomy was sent to each one of them for review and feedback. The following will introduce each expert and present his opinion about the taxonomy.

The first expert is Dr. Russ Saypoff, MD. Dr. Saypoff is an interventional radiologist specializing in minimally invasive treatments for varicose veins, thrombosis, peripheral arterial disease (PAD), and dialysis access management. He is the Medical Director of American Access Care in Hauppauge, New York. He is affiliated with Stony Brook University Hospital, Burke

Rehabilitation Hospital, and NewYork-Presbyterian Brooklyn Methodist. Dr. Saypoff validated the taxonomy saying “I believe that this taxonomy is valid.” He just questioned the robustness of it but it was good enough for this research.

The second expert is Dr. Rodrigo Rubio. Dr. Rodrigo is a specialist in anesthesiology. He is the general coordinator of the Postgraduate Simulation Center of the American British Cowdray (ABC) Medical Center in Mexico City. In addition, he is an associate professor, anesthesiology, National Autonomous University of Mexico (UNAM). He is also faculty in the Institute for Medical Simulation, Boston, MA, USA. Dr. Rodrigo validated the taxonomy saying “I like very much your primary category. There was an abstract some years ago from the University of Florida which classified simulation in human, physical and virtual. Then connected human and physical creating hybrid. Physical and virtual creating a mixed simulation and virtual with human creating augmented reality. I like yours better because of the hybrid and possible connection between all of the 4 types. Also it is very understandable”.

The third expert is Dr. Tania Rocio Garibay. Dr. Garibay is a medical surgeon from the Faculty of Medicine, with Specialty in Pathology and Sub-Specialty in Neuropathology by the Faculty of Medicine of the UNAM and the General Hospital of Mexico. She is an expert in PBL (Problem Based Learning) cases and integrating this technique with healthcare simulation in a subject named “Medical Sciences Integration”, she has a Master in Education and she is a medical professor of Cellular and Tissue Biology in the Faculty of Medicine, UNAM, since 2006. Additionally, she is a visiting professor in the General Hospital of Mexico, and the head of instruction and research of the Specialty Regional Hospital of Ixtapaluca. Dr. Garibay is a contributing author of the Practical Manual in Cellular Biology and Medical Histology - UNAM. Dr. Garibay validated the taxonomy saying “This is a very useful taxonomy that can be used as a

worldwide validation and classification of healthcare simulation. We are currently facing a rupture of educational paradigms and it is necessary to use new technologies such as clinical simulation to improve learning and student skills. If we manage to have international classification standards like this basic taxonomy, we will begin to understand the experiences of each institution regardless of the country of origin and in that way, we can work along the same line of understanding.”

4.4 Comparing the Existing Models

In this section, the strengths and weaknesses of each model will be discussed in details in order to develop a better understanding of the models.

4.4.1 Strengths and weaknesses of the Kirkpatrick-Phillips Model

J. J. Phillips (2003) expanded on Dr. Kirkpatrick's Four Levels of Evaluation for measuring performance in Training and Human Performance Technology (HPT) programs: reaction (level 1), learning (level 2), behavior (level 3), and results (level 4) by adding the (5th level) of ROI Methodology for training and HPT programs. His improved method estimates the business value to the organization based on a particular investment or project to determine a framework for gathering program data to support and improve established training and performance programs.

Phillips's ROI framework integrates techniques used to evaluate the effectiveness of training programs. The methodology estimates the impact of the training by obtaining information about the estimated performance improvement, that resulted from the training, directly from program participants. Then, the senior management adjusts the estimates of the participants. The

importance of these adjustments comes from the broader perspective of the senior management to the overall performance of the entire organization. In fact, there are several factors that will affect performance data after training that the lower level employee would not take in the consideration or not even aware of. Phillips reports that the effectiveness of his methodology rests on the hypothesis that participants who take the training are able to estimate the magnitude of performance improvement that resulted from the actual training program. This model recommends using carefully crafted questionnaires to obtain this information. The questionnaires are to be filled by the trainees before and after the training, and then adjusted by the senior management. Then, the computation of the qualitative aspects of ROI can be done.

One of the strengths of this model is that it enables gathering the information from different levels. The first level is the trainee level to estimate the magnitude of improvement. This offers the opportunity to get estimates from the direct beneficiary from the training; from those whose performance will be directly impacted by the training. Practically, this level will provide the most accurate estimates regarding the actual improvement that results from the training.

Since the initial estimates of improvement come from the trainees, these estimates most probably will not take in consideration the higher organizational level factors that could have a significant impact on the actual performance improvement. Therefore, allowing the executive management to adjust the trainee's estimates is another strength of this model. This step enables improving the accuracy of the estimated incorporating that higher management normally takes into consideration while normal employees do not.

Another strength is gathering the information in several stages of the training. As this model gathers information before and after the training, this enables the trainee to give a more

accurate estimation of the improvement in performance. This also can help in identifying and isolating the effects of the training in order to evaluate the actual benefits of the training and as a result, calculating the ROI of the training.

Although this methodology has strengths, there are several challenges and weaknesses that are associated with it and should be taken into account. One of the weaknesses of this model is the focus only on the benefits that are directly related to the performance improvement. It does not support the inclusion of some indirect or secondary benefits which could be essential and impactful to the ROI. For example, the reduction in the lawsuits and the legal consequences of the poor performance or medical errors.

The other major challenge of this model is its dependence on questionnaires as a data collection tool. Therefore, all the challenges that are applicable to questionnaires as a data collection method are applicable to this method. For example, badly framed questions or poorly structured questionnaires can simply discourage participants and lead to low response rates. Additionally, any uncertainty in the interpretation of any questions can cause doubt on the validity of the data that are obtained (Clarke & Dawson, 1999).

In addition to that, there is almost no way to determine how truthful respondents are being. In addition, there is no way of knowing how much thought a respondent has put while responding to the questionnaire. Moreover, the participant may be forgetful or not thinking within the full context of the situation. Additionally, people read, understand, interpret each question differently and as a result, respond according to their own interpretation of the question. For example, what is considered to be 'good' to someone, might be considered 'poor' to others. Therefore, it is difficult to acknowledge the level of subjectivity (Ackroyd, 1992). The following Table 4-1: Strengths and

weaknesses of the Kirkpatrick-Phillips Model.

Table 4-1: Strengths and weaknesses of the Kirkpatrick-Phillips Model

Strengths	Weaknesses
<ul style="list-style-type: none"> • Uses five levels of evaluation for measuring performance in Training and Human Performance Technology and the ROI. • Gather the information from those who their performance will be directly impacted by the training. • Allow the executive management to adjust the trainee's estimates to enable improving the accuracy of the estimates incorporating a higher organizational level factors. • Gather the information in several stages of the training. • Identify and isolate the effects of the training 	<ul style="list-style-type: none"> • Focuses only on the benefits that are directly related to the performance improvement. • Depend on questionnaires as a data collection tool. <ul style="list-style-type: none"> ○ Badly framed questions or poorly structured questionnaires can simply discourage participants and lead to low response rates. ○ Uncertainty in the interpretation of any questions can cause doubt on the validity of the data that are obtained. ○ No way to determine how truthful respondents are being.

4.4.2 Strengths and weaknesses of Frost and Sullivan Model

Frost and Sullivan (2004) evaluated the ROI of three training simulators: CathSim Vascular AccuTouch System, Endoscopy AccuTouch System, and Laparoscopy AccuTouch System (w/LapSim modules) over a five-month period (October 2003 – March 2004). The objective of the study was to build an interactive ROI calculation model using Monte Carlo simulations.

Frost and Sullivan's model has several strengths. One of the strengths is the wide range of professionals who were interviewed to identify the contributing factors. Surveys and interviews were conducted with a sample of 237 individuals that included staff physicians, residency directors, nursing directors, nurses, risk managers, and CFOs or controllers in hospitals, Universities and Community Colleges across the United States in order to identify the factors that contributed in the ROI determination. This helped in including and considering the most important factors with taking in consideration various perspectives including management, academic, professional, clinical, and technical perspectives.

Another strength is that the objective of the study was to build an interactive ROI calculation model using Monte Carlo simulations. Therefore, the model has the capability of simulating different scenarios which provide the opportunity to examine the influence of each factor on the overall ROI of the training simulator. This model was a comprehensive one for these three specific training simulators.

On the other hand, the major weakness of this model is its restriction and limitation to the three specific simulators that it was developed for. This limits the usability of this model for other several types and forms of training simulators. The following Table 4-2: Strengths and weaknesses of Frost and Sullivan Model.

Table 4-2: Strengths and weaknesses of Frost and Sullivan Model

Strengths	Weaknesses
<ul style="list-style-type: none"> • A wide range of professionals was interviewed to identify the contributing factors. • included the most important factors with taking in consideration various perspectives including management, academic, professional, clinical, and technical perspectives. • Built an interactive ROI calculation model using Monte Carlo simulations. • The capability of simulating different scenarios which provide the opportunity to examine the influence of each factor on the overall ROI of the training simulator. 	<ul style="list-style-type: none"> • This model is restricted and limited to the three specific simulators that it was developed for. • This limits the usability of this model for other several types and forms of training simulators.

4.5 The benefits and cost structure

4.5.1 Benefits Structure

Now that we studied the existing models, we can develop a structure for the benefits and cost. This structure should enable identifying tangible and intangible benefits. In addition to that, it should consider the different cost that is associated with the simulation-based training.

The benefits section of this structure, shown in Figure 4-5, uses the major categories of VMM value structure, which include: direct, social, operational, strategic, and financial values, to identify tangible and intangible values, qualitative and quantitative benefits of the medical training simulation program. This is accomplished by considering benefits that are pre-identified by other studies such as the Frost and Sullivan (2004) ROI study for SBT medical training and could be improved by several tools including questionnaires and/or interviews of experts. This part specifies what are the factors that will be included in the ROI analysis. The more contributing factors identified, the more comprehensive and accurate the outcomes.

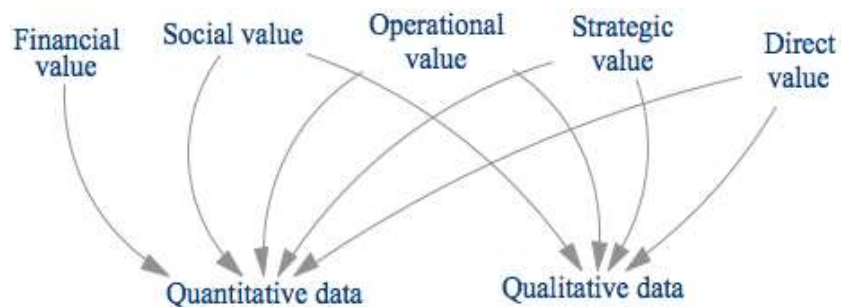

Figure 4-5: The benefits section of the benefits and cost structure

4.5.1.1 Key Measures and Factors Identification

The assessment of the ROI of a medical training simulator starts with the identification of the key impact measurement of the simulator that should be considered in the ROI analysis. For example, in the ROI analysis of a central venous catheter (CVC) simulation-based training program for the medical intensive care unit (MICU) at Northwestern Memorial Hospital (NMH), Pastrana et al. (2014) identified medical care cost, length of stay, and number of complications as key impact factors as important measurements for inclusion in analysis. The measures that should be influenced by the simulator depend on the objectives pursued in acquiring the simulator. The identification process is facilitated by considering the major categories of VMM value structure, which include direct, social, operational, strategic, and financial values.

There are several ways and strategies to identify the measures including questionnaires and/or interviews with experts and executives, especially those who are involved in decision-making regarding the simulator acquisition. Additionally, considering the pre-identified measures for the common types of simulators is an effective method to begin with. For example, measures identified by other studies like the Frost and Sullivan ROI study for SBT medical training and Dr. Phillips in his book *Measuring ROI in Healthcare: Tools and Techniques to Measure the Impact and ROI in Healthcare Improvement Projects and Programs*. The following Table 4-3 contained examples of the tangible and intangible factors that can be considered for the analysis.

Table 4-3: examples of the tangible and intangible factors

Category	Possible Factors
Direct Value	<ul style="list-style-type: none"> • Improve quality of training • Improve the accessibility to training program
Social Value	<ul style="list-style-type: none"> • Reduce the impact of medical errors on families' quality of life. • Better health and lower health care cost
Operational Value	<ul style="list-style-type: none"> • Speed diagnosis • Speed in treatment – bedside • Reduction in diagnosis errors • Reduction in treatment errors • Additional # OR procedures per year • Reduction inpatient length of stay
Strategic Value	<ul style="list-style-type: none"> • Reduce the number of lawsuits • Improvement of patient safety • Improvement in the reputation of the organization • Employee satisfaction • Employee turnover rate • Patient loyalty
Financial Value	<ul style="list-style-type: none"> • Provide direct training to other organization • Increase revenue • Reduced cost

4.5.1.2 Converting qualitative and quantitative measure to tangible values

The outcome of identification process of key measurements is categorized into qualitative and quantitative measures. Quantitative data is easy to transfer to monetary value and considered as a tangible value. Qualitative data included within the tangible values depends on the level of credibility of the converted data. Values lose credibility if the process used for the conversion is too subjective or inaccurate. The determination of lost value follows the guidelines described by Phillips. Qualitative data has two scenarios. The first is when the data can be converted to monetary values with high credibility. In this scenario, the data should be converted and included as a tangible value. The second scenario, if the data cannot be converted to monetary value with high credibility, then, it is considered as an intangible measure. Therefore, tangible measures include qualitative data and quantitative data when converted to monetary values with high credibility.

4.5.1.2.1 Steps to Convert Measures to Monetary Values

The following steps have to be applied for each measure in order to convert it to monetary value:

1. Identify the unit of measure: for quantitative measure it is easier to identify the measuring unit, for example, the number of operations done in the OR. It is more challenging to identify measuring units for qualitative measures. For example, one unit of improvement in patient satisfaction index. In general, for quantitative measures, there are commonly used measures, but for qualitative measures, there have been some measures that are getting more commonly used by the healthcare community.

2. Determine the value of the unit: standard values are available for the majority of data types. If the standard value is not available, there are several techniques to identify the value of the unit. The selection of the technique is based on the type of data and the situation in which the data is gathered and intended use. Techniques include analyzing historical data, the use of internal and external experts, the use of external databases, and estimates of participants and managers.
3. Calculate the change in performance: this is the isolation of the impact of the simulator on the specific measure. It is described in the next section.
4. Determine the annual amount of change.
5. Calculate the annual value of the improvement: this can be done by multiplying the annual performance change by the value of the unit.

4.5.1.3 Isolating and Evaluating the Impact of the Simulator

The next important step is to isolate the effects of the simulator. There are several approaches to isolate the impact of the training simulator. In general, there is no one single best approach to isolate or evaluate the impact of the simulator. Therefore, impact evaluation approach could vary based on the nature of the specific measure being considered. An analytical approach could be applied by using control groups, trend line analysis, or forecasting methods.

The other approach is the estimation. One way to use estimation to identify the human performance improvement developed as a result of the training is Dr. Phillips strategy to estimate the improvement. The initial estimate *should* be done through a questionnaire that trainers and trainees take prior to and after the training to estimate their performance improvement due to the training and confidence levels in the estimations. Decision makers then review and adjust the estimations and identify the important factors and parameters that need to be considered in the calculations of the ROI (J. Phillips et al., 2013).

4.5.2 Cost Structure

Cost and expenditures of the simulation-based program are the other major factor that contributes to the ROI analysis. Consequently, it is an essential part of the cost and benefits structure of the solution. The cost analysis should take into consideration all the cost associated with the program. Therefore, the cost can be classified into two major categories: project phase cost and operational phase cost. Both categories should be included in the total cost for accurate and credible calculation. The cost structure is summarized in Figure 4-7

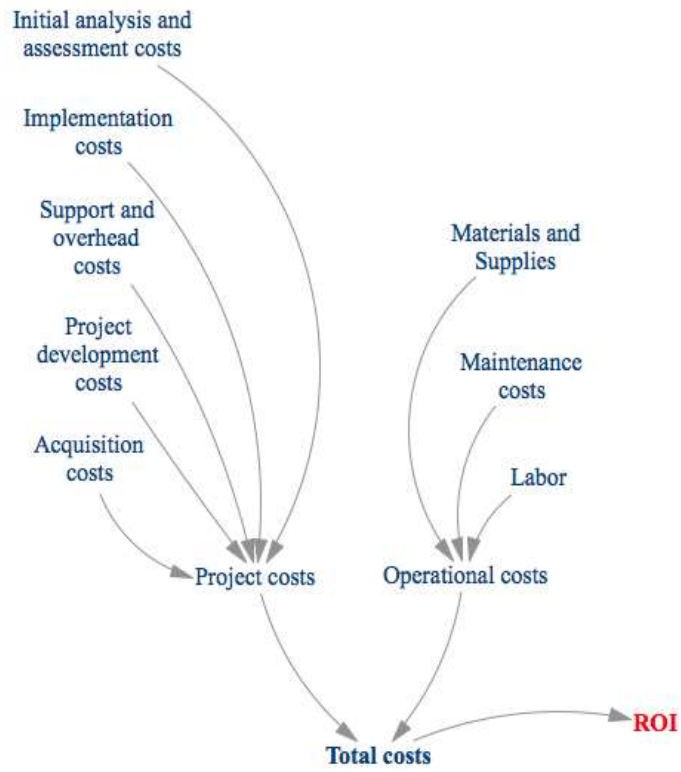

Figure 4-7: The cost section of the benefits and cost structure

4.5.2.1 Project phase cost

Project phase cost is the cost and expenditures to acquire and develop the training program and all the resources required for the program. It, also, include initial analysis and assessment cost, the cost of development of the project, acquisition cost, and implementation cost. These are the major cost categories associated with projects, and any other cost can be classified under one of these major categories. Figure 4-8: Project phase cost.



Figure 4-8: Project phase cost

It is important to point out that project cost will vary based on the type of simulation-based training being considered. Therefore, the project cost could be major in the case of sophisticated simulators where the major cost goes toward acquiring the equipment. In other cases, project cost could be minor when no sophisticated simulator is required. The following Table 4-4 is an example of a project and operational cost from Andreatta et al. (2011) for simulation-based mock codes at

the University of Michigan tertiary care academic medical center. In the following Table 4-4 we can see the project cost highlighted in blue. The rest are considered operational cost.

Table 4-4: Example of project and operational cost

Item	per unit cost	units	subtotal
Physician Start Up	125	40	5,000
Physician Routine	125	240	30,000
Faculty Educator Startup	80	80	6,400
Faculty Educator Routine	80	240	19,200
Coordinator Start up	60	40	2,400
Coordinator Routine	60	240	14,400
Simulation Technician Startup	60	80	4,800
Simulation Technician Routine	60	240	14,400
Simulator Purchase	50,000	1	50,000
Simulator Maintenance	7,500	4	30,000
Materials/Supplies	1,500	4	6,000
Equipment	5,000	1	5,000
Facilities	250	240	60,000
Participants	900	160	144,000
TOTAL PROGRAM COST			391,600

4.5.2.2 Operational phase cost

Operational phase starts right after the project phase is finished. It is when the actual use of the training program begins. Operational phase cost, shown in Figure 4-9 includes maintenance cost, support, overhead cost, labor, facility, student time cost, and materials supplies. These are the major cost categories associated with operations, and any other cost can be classified under one of these major categories. The previous Table 4-4 is an example of project and operational cost. Project cost highlighted in blue. The rest are considered operational cost.



Figure 4-9: Operational cost

4.5.3 Summary of benefits and cost structure

Figure 4-10 summarizes the relations between factors contributing to ROI. It also depicts the different parameters that should be considered for ROI evaluation. Section (a) of the figure shows the different types of cost and has two categories: project and operational cost. Section (b) shows the categories that help in identifying the key parameters and measures. These measures are classified into qualitative and quantitative. Section (C) shows the transformation of qualitative and quantitative measures into monetary value, tangible values, which is done using Dr. Phillips methodology. It also shows that part of the qualitative measures cannot be transformed into monetary value with high credibility, and as a result, will be considered as an intangible value and will not be considered for the calculation part of the ROI but it will help decision makers to make informed decisions.

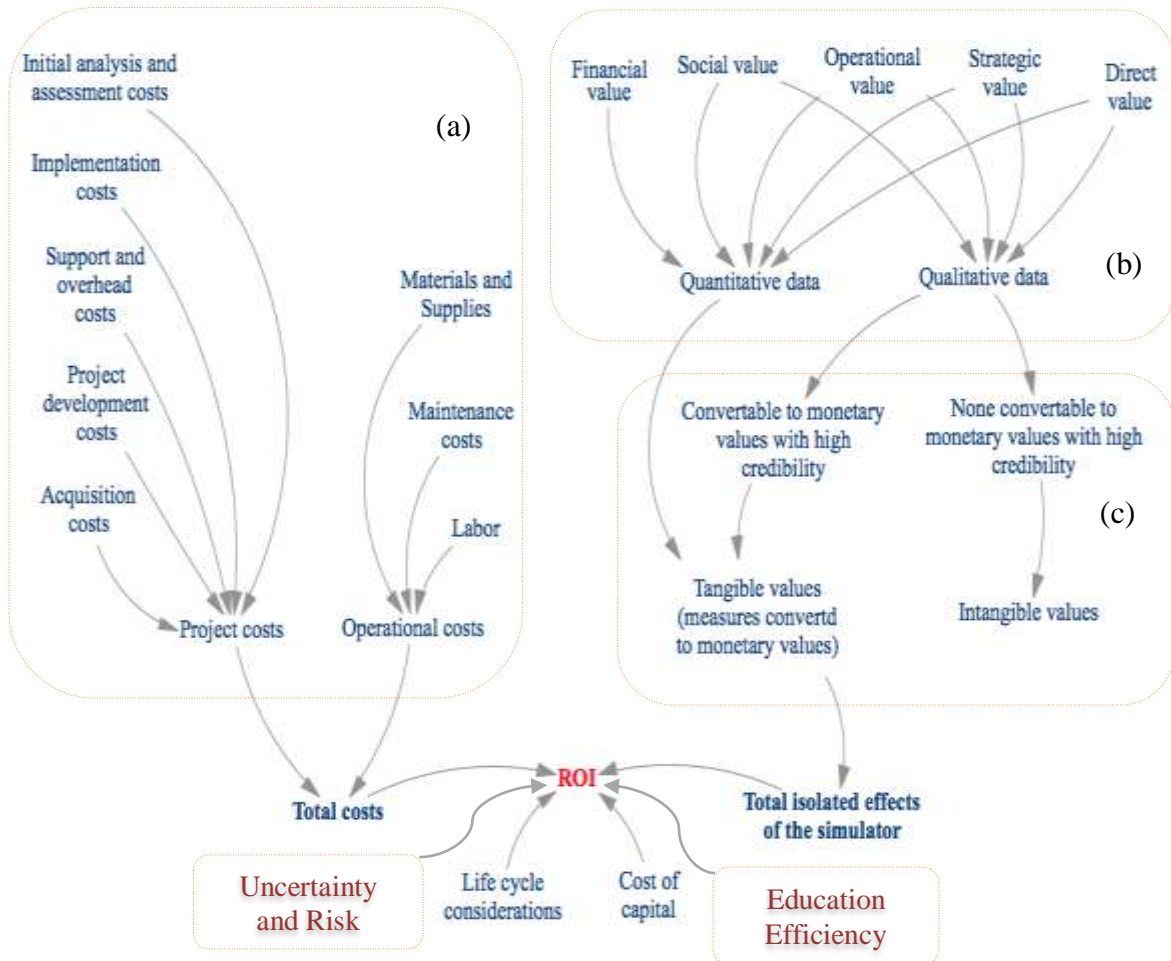

Figure 4-10: Cost and Value Structure of Factors Contributing to ROI

4.5.4 Case Study of applying the benefits and cost structure of the framework

The case study in this section will demonstrate the application of the value and cost structure. This case study provides real data from Andreatta et al. (2011) related to the correlation between the pediatric patient cardiopulmonary arrest (CPA) survival rates and a simulation-based mock codes at the University of Michigan tertiary care academic medical center. The objective of this study was to assess the effectiveness of the training on patient outcomes at residents' confidence in performing resuscitation. This study was conducted over a 48 month, in which mock codes were called on an increasing rate and the clinicians responsible for pediatric resuscitation are required to respond just as they would on and the actual CPA event. Events were recorded and performance feedback was given by clinical faculty to the participating clinician's residents, nurses, allied health, and attending physicians. The CPA survival rate for the hospital before and during the study was examined. The results of this study showed that the survival rate was increased by approximately 50% correlating with the increasing number of mock codes.

The application of the value and cost structure will start with developing the cost structure of the training, then the identification of the key parameters to be included in the ROI assessment using the different VMM categories. Next, the conversion of qualitative and quantitative data to tangible values will be executed. After that, the effects of the training will be isolated in order to evaluate the ROI of the training compared to its cost.

4.5.4.1 The cost structure of the simulation-based training

Table 4-5 includes the details and totals of the cost of the training. These include start-up cost for developing the scenarios, programming the mannequins, coordinating the delivery, and designing the assessment/evaluation strategies. There are also cost associated with the routine occurrences of the program, which include hourly rates for those who contributed to the start-up as well as the participants who were active during the mock code (average rate for the team is used). The cost of the simulator, ancillary equipment, materials and supplies are included, along with the maintenance agreements for the period of time the program took place. Facility charges are per hour for the code time only.

Table 4-5: Details and totals of the cost of the training

Item	Per unit cost	Units	Subtotal
Physician Start Up	125	40	5,000
Physician Routine	125	240	30,000
Faculty Educator Startup	80	80	6,400
Faculty Educator Routine	80	240	19,200
Coordinator Start up	60	40	2,400
Coordinator Routine	60	240	14,400
Simulation Technician Startup	60	80	4,800
Simulation Technician Routine	60	240	14,400
Simulator Purchase	50,000	1	50,000
Simulator Maintenance	7,500	4	30,000
Materials/Supplies	1,500	4	6,000
Equipment	5,000	1	5,000
Facilities	250	240	60,000
Participants	900	160	144,000
TOTAL PROGRAM COST			391,600

4.5.4.2 Identifying the key parameters and collecting the data

The benefits and cost structure recommends considering the five major categories of value from the VMM: direct, social, operational, strategic, and financial value. Apart from the direct impact on social value, the strategic value of patient safety, and financial value of the increased neonatal/pediatric CPA survival rate, this case study will consider the intangible factor of turnover rate of physicians, which has a strategic and financial impact on healthcare organizations.

Physician turnover is a very costly problem for healthcare organizations. According to Fibuch and Ahmed (2015), the negative impact of physician turnover should be a big concern for healthcare organizations as it has an impact on the profitability and the quality of care. In addition to the hiring and training cost, negative impacts such as productivity losses, noteworthy loss of organizational history, knowledge and expertise, disturbance of the morale of the remaining employees, and potential adverse publicity for the organization are expected. Therefore, the study highlighted the importance of incorporating employee retention strategy and considered the opportunities for advancement and learning new skills among the important factors of employee retention strategy. Considering the advancement opportunity provided by simulation-based training justify incorporating the cost saving of employee retention in ROI analysis.

4.5.4.3 Converting qualitative and quantitative data into tangible values

Computation of turnover cost and understanding its implications in healthcare are conceptually challenging because of three reasons. First, health care is simultaneously driven by market forces and controlled by regulation and as a result, accounting concepts cannot be applied

directly to health care without major adjustment. For example, revenue does not equal reimbursement nor does cost equal charges. Second, the mathematical computation of cost is complex and varies with the type of employee and employer as the turnover cost of physicians is far more complex than it is maintenance staff. Third, due to the difficulty of attributing revenues and cost, the net effect of the turnover is almost non-calculable (Waldman, Kelly, Arora, & Smith, 2010). Therefore, in this case study, we will consider the out of pocket cost that has been mentioned in Waldman et al. (2010).

4.5.4.4 Isolating the effects of the training

Waldman et al. (2010) used several databases at an academic medical center as a foundation for measuring the cost of employee selection, hiring, and training, as well as qualitative and quantitative yardsticks used to measure employee productivity. Waldman et al. (2010) study drawn accounting records and data for specific organizational units within the academic medical center and categorized the cost of turnover by the phase of recruiting process: hiring, training, working, and termination. Estimates have been made in few instances. Even though the study has estimated the average turnover cost for about 6 categories of employee, in this case study, only the turnover cost of physicians and nurses will be considered.

- The average cost of replacing a physician including \$36,743 hiring cost, \$89,800 training cost, and \$43,250 average loss of productivity to bring the total cost to \$169,793 (about \$170,000).

- The average cost of replacing a nurse including \$ 1,635 hiring cost, \$ 15,825 training cost, and \$10,026 average loss of productivity to bring the total cost to \$27,486 (about \$27,500).
 - There is another source that has mentioned the average nurse replacement cost as \$42,000 and \$64,000 in some cases (Rondeau, Williams, & Wagar, 2009)

Note: Cost to train individuals involves mandatory courses, orientation classes, and reimbursed time when not generating charges.

4.5.4.5 Calculating the ROI

Despite the fact that we could not find actual data on the change of turnover rates for our particular case study, several studies have shown a connection between lower turnover and making investments in the training and development of human resources in healthcare (Rondeau et al., 2009; Waldman et al., 2010).

The following assumptions will be used in ROI calculations: over the 48 months of the simulation-based training, at least one physician and one nurse every year has preferred not to leave the organization because of the training opportunity.

- The annual cost saving of retention will be = \$170,000 + \$27,500 = \$197,500 per year
- The cost saving over the 48 months of implementation = 4 * \$197,500 = \$790,000 for 4 years

$$\text{ROI (\%)} = \frac{\$790,000 - 391,600}{391,600} * 100 = \% 101.7$$

4.5.4.6 Discussion

The benefits and cost structure presented herein enables the determination of ROI with the consideration for both tangible and intangible values and benefits resulting from simulation-based training, including demonstrated the application of the benefits and cost structure to a specific case study. The application of the benefits and cost structure for this specific case study considered only a single aspect of the value categories of the VMM, with demonstrated %101 ROI for this one aspect alone; a convincing ROI to help the decision-making process. If other aspects were considered in the evaluation, the ROI would be further developed to accommodate both tangible and intangible outcomes and provide a more comprehensive analysis. A limitation of this study is that these data were not available for the analyses conducted for the case study, however the benefits and cost structure provides a foundation for the types of data that would be beneficial for future studies evaluating the ROI of institutionally supported simulation-facilitated environments.

However, the purpose of this case study is to examine the applicability of the cost and benefits structure and it did not take into consideration the uncertainty that is associated with the cost and benefits. Therefore, we recommend further analysis to count for the uncertainty and to benefit from the flexibility embedded in the investment. This point out the importance of using techniques that has the capability to deal with analyzing different scenarios like Monte Carlo analysis and others that can value the embedded opportunities such as Real Options Analysis. For this purpose, these techniques will be discussed in future sections of this chapter to explore if they can add value to the framework and should be adopted by the framework.

4.6 Value Analysis

The expected value of the investment is one of the most important criteria that decision-makers would need to properly evaluate and decide on any investment. Net present value (NPV), Internal rate of return (IRR), Accounting rate of return (ARR), and Payback are among the several investment evaluation methods, but Real Options (RO) theory is considered to be the latest expansion of conventional investment evaluation techniques (Csapi, 2013). Real options theory is about applying the concepts of financial options valuation to evaluate the feasibility of real-life projects. RO application helps in exploring and evaluating the options that the management has to adjust projects in response to new circumstances arise with the evolution of uncertainties (Martínez Ceseña, Mutale, & Rivas-Dávalos, 2013).

Traditional financial theory suggests using Discounted Cash Flow (DCF) approach to analyze investments. Net present value (NPV) is one of the most commonly used techniques based on DCF. NPV is the measure that indicates the added or created value that resulted from the investment (Ross, Westerfield, & Jordan, 2008). However, the assumptions made in calculating the value of investments have some drawbacks. According to Miller and Park (2002) these methods require the assumption of certainty of project cash flows, but become inaccurate when used to evaluate strategic investments where the payoff is uncertain. In addition to that, DCF technique disregards the need for flexibility to modify decisions during the course of the project, as and when new information arrives. Therefore, this framework recommends using Real Options approach, which considers the flexibility when evaluating the value of the investment.

4.6.1 Real Options Approach

“The term Real Options initially used by Stewart Myers in 1977 when he was investigating the possibilities of pricing to property investment valuation domain, not in the financial domain as it usually used for. Considering the level of uncertainty in the investment, deferring or adjusting investments or production decisions are real options that can be considered. This consideration uses the flexibility in the project to increase its value if the analysis revealed that one of these options could increase the value of the investment” (Triantis, 2000). In the 80s and 90s, this application shift caught moderate academics’ attention, but by mid 90s, real options became more generally accepted by science rather than being accepted only for those who have specialized interest in options theory (Borison, 2005).

The main advantage that reinforced RO to grow and get accepted is its consideration of the uncertainty and flexibility of active decision-making. On the other hand, ordinary and easy to apply methods based on instructive discount cash flows ignore the revelation of uncertainty, which proposes passive management and decision-making. This is an predictable outcome of using a single scenario whereby projects expected to begin immediately and at last to the end of expected useful life in continuous operation. This is a form of undervaluing the project by ignoring the added value of flexible adaption and innovation that could contribute significantly to the value of the project (Csapi, 2013).

Taking advantage of favorable investment opportunities, limiting losses, and/or responding to competitors’ movements and technological changes have become essential for management and decision makers in order to be flexible and responsive enough to survive and succeed in the highly uncertain and dynamic global market. In order to increase profitability, revenues, and productivity,

and reduce cost and losses, the decision makers should consider and analyze all the available options for the business they are running including expansions if projects are doing good, abandoning if projects are doing bad results, suspend, or contract processes (Trigeorgis, 2005). Trigeorgis' options approaches include the option to defer investment, the option to stage investment, the option to expand, the option to contract, the option to temporarily shut down, the option to abandon for salvage value, the option to switch inputs or outputs, and corporate growth options.

4.6.2 Real Options Theory

Real options theory is the application financial options valuation's concepts to the evaluation of real-life projects. Financial options can be defined as contracts between two parties that provide the right but not the obligation to trade products for a predetermined price at a specific time (Martínez Ceseña et al., 2013). Table 4-6: Analogy between financial and real options.

Table 4-6: Analogy between financial and real options

Financial options	Real options
Stock price	Present value of cash flows from the project
Exercise price	New investment required
Time to expiration	Length of time until decision must be made
Risk-free rate of return	Time value of money
Volatility	Risk of expected returns

4.6.2.1 Real Options Types

Options can be classified into two categories: simple options and compound options. According to Padhy and Sahu (2011) and Martínez Ceseña et al. (2013), the proposed simple real options at the time are the following:

1. Defer RO, which are alternatives to delay investment decisions with the objective of gathering information. The option that provides the management to wait or delay the investment in the project with a hope that the future information will decrease the decision risk.
2. Time to build RO, which entails the execution of an investment in several stages. This provides the management an opportunity for sequential investment approach.
3. Alter operating scale RO, which are options to either expand or shrink a project or investment. This option that provides the management the opportunity to expand or reduce the scale of investment.
4. Abandon RO, which entails selling the project if it generates losses
5. Switch RO, which are alternatives to change the output or input mix of the projects
6. Growth RO, which are options to invest in pilot projects before building a large project. This option provides the management an opportunity for future follows on investments.

Compound options are “applicable for multistage project investment where the management has the opportunity to decide on expanding scaling back maintaining the status or abandoning an investment project after gaining new information that resolves the uncertainty

associated with the investment” (Kodukula, 2006). The combined option can be sequential or simultaneous, parallel. The sequential options are when an option is created as a result of the execution of a prior option. In another word if you have to execute an option in order to generate one: This is a called a sequential option. The parallel option is when both options are available at the same time.

4.6.3 Procedure for determining the real option value (ROV) of the investment

Determination of the option value of the investment can be done through the following steps: framing the application, identification of input parameters, calculation of input parameters, generation of the binomial tree, and calculating the options value at each node. Each step is discussed in details in the following sections. The following Figure 4-11: Procedure for determining the ROV of the investment.

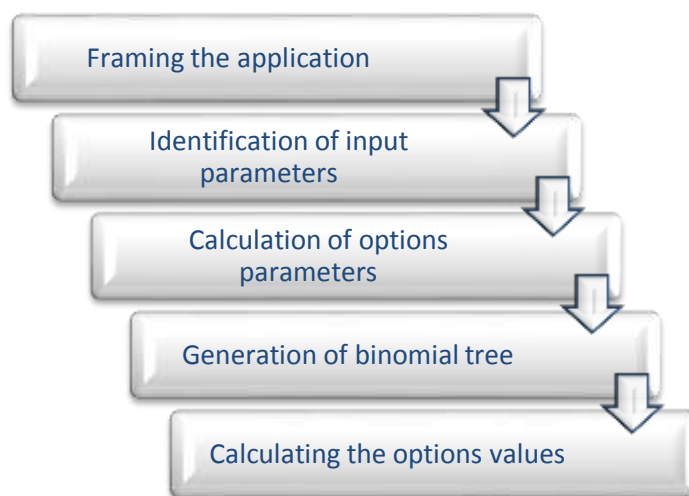

Figure 4-11: Procedure for determining the ROV of the investment

4.6.3.1 Framing the application

In this step, the problem is described and the different options at each major decision are identified in order to be considered in the different scenarios. Considering the six commonly used options type is helpful as a starting point. However, options are not limited to these six types and any viable option can be considered.

4.6.3.2 Identifying the input parameter

There are six major input parameters that are required to be able to model the uncertainties through the binomial method and find out the Real Options value of the investment. These six parameters are the following:

1. Current value of the underlying asset (S_0)

The current value is estimated from the cash flows the project is expected to generate over the project life cycle. The present value of the expected free cash flows based on the DCF technique is considered to be the same as the value of the underlying asset.

2. Strike price/option's exercise price (X)

The strike price or option's exercise is the present cost of all the expenses made for the investment over the life cycle taking into account an annual discount rate.

3. Option life of the investment (T) is the life time intended for the investment.
4. Chosen interval size (δt)

Interval time is the time when a point of decision between available alternatives within the lifetime of the investment.

5. Volatility of the asset value (σ)

Volatility is an indication of the variability of the overall value of the underlying asset over its lifetime. It signifies the uncertainty associated with the cash flows that comprises of the underlying asset value. It is an important input variable that can have a significant impact on the option value (Padhy & Sahu, 2011).

The Volatility (σ) can be estimated in several approaches including logarithmic cash flow return, Project Proxy Approach, Market Proxy Approach and Management Assumption Approach. Historical data is essential for all these approaches except the management assumption approach. Therefore, and because of the unavailability of this type of data so far, management and experts' assumption approach will be adopted for this framework.

In this approach, management and experts estimates optimistic (S_{opt}), pessimistic (S_{pes}) expected payoffs for a given investment lifetime (t). Assuming the payoff follows lognormal distribution, it is computed with the following formula:

$$(\sigma) = \ln\left(\frac{S_{opt}}{S_{pes}}\right) / 4\sqrt{t}$$

6. Risk-free interest rate (r_f). It is normally based on the U.S. Treasury spot rate return.

4.6.3.3 Calculation of the option parameter

The option parameters are the factors that help us to *estimate* how much this value is likely to move up or down. These factors are the *Up factor* (u) and the *Down factor* (d) in addition to the risk neutral probability (p). These can be calculated using the following formulas:

$$\text{Up factor } (u) = e^{\sigma\sqrt{\delta t}}$$

$$\text{Down factor } (d) = 1/u$$

$$p = (e^{r\delta t} - d) / (u - d)$$

4.6.3.4 Generation of the binomial tree

In order to generate the binomial tree, the asset values at each node of the tree need to be calculated. Starting from an initial expected value S_0 moves up to uS_0 with probability p or down to dS_0 with probability $1-p$, in a fixed interval δt . Then, we estimate the option values (OV) by backward induction. Figure 4-12: The Binomial Tree is displayed.

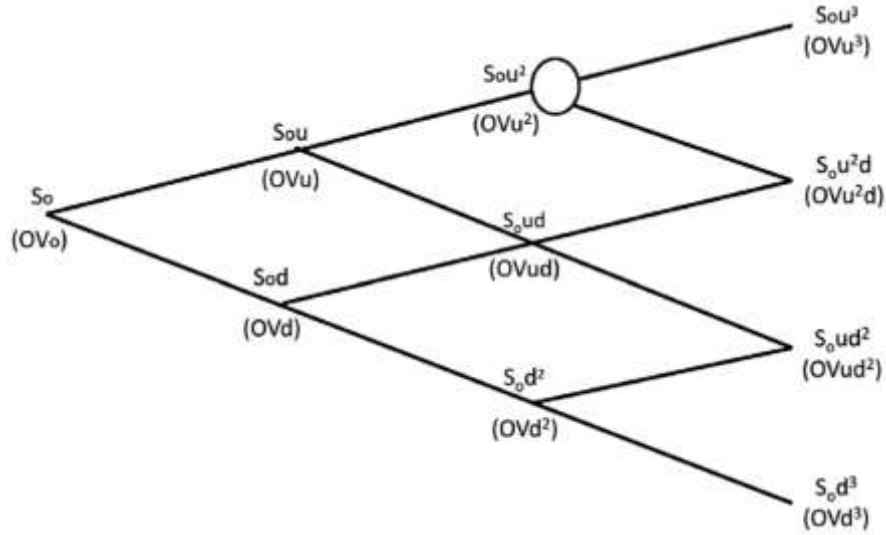

Figure 4-12: The Binomial Tree

4.6.3.5 Calculating the option values at each node by backward induction

To compute the option value OVu^2 , we need to calculate the waiting, call, and put option as follow:

$$\text{for waiting: } OVu^2 = [(p(OVu^3) + (1 - p)(OVu^2d)]. e^{-r\delta t}$$

$$\text{For call option: } OVu^2 = \max(S_0u^2 - X, 0)$$

$$\text{For put option: } OVu^2 = \max(X - S_0u^2, 0)$$

Then, we select the highest value. The same process is repeated until the beginning to the get the option price of the project (OV_0).

The next and final step is analyzing and interpreting the results in order to make it meaningful and useful for the decision makers.

The next case study application of real option analysis to the case study of the correlation between the pediatric patient cardiopulmonary arrest (CPA) survival rates and a simulation-based mock codes at the University of Michigan tertiary care academic medical center discussed above will demonstrate the application procedure to make it more understandable, and will reflect the benefits of the real options approach.

4.6.4 The application of Real Options approach to the Case Study

This section is a demonstration to the procedure of the application the Real Options analysis to the case study of the correlation between the pediatric patient cardiopulmonary arrest (CPA) survival rates and a simulation-based mock codes at the University of Michigan tertiary care academic medical center discussed above.

In case of missing some data, proper assumptions will be stated in order to fulfill the required data for the analysis.

This application will follow the above-proposed steps of: framing the application, identification of input parameters, calculation of input parameters, generation of the binomial tree, and calculating the options value at each node of the tree.

4.6.4.1 Framing the application

This case study uses some assumptions in addition to the real data from Andreatta et al.

(2011) related to the correlation between the pediatric patient cardiopulmonary arrest (CPA) survival rates and a simulation-based mock codes at the University of Michigan tertiary care academic medical center. The objective of this study was to assess the effectiveness of the training on patient outcomes at residents' confidence in performing resuscitation. This study was conducted over 48 months, in which mock codes were called on an increasing rate and the clinicians responsible for pediatric resuscitation are required to respond just as they would on and the actual CPA event. Events were recorded and performance feedback was given by clinical faculty to the participating clinician's residents, nurses, allied health, and attending physicians. The CPA survival rate for the hospital before and during the study was examined.

We will assume that the current training and development program of this unit has an expected present value of savings of \$160 thousands over the coming 4 years using DCF. Using management assumptions approach, the annual volatility of the cash flows is 30%. The management is expecting an improvement of threefold of savings over the coming 4 years in the case of implementing the considered mock codes on an increasing rate and the clinicians responsible for pediatric resuscitation will be required to respond just as they would on and the actual CPA event. The cost of this training is expected to be about \$400 thousands over the coming 4 years. The risk-free interest rate (annual) for the particular period is assumed to be 5%.

We need to calculate the simulation-based training option over the 4 years.

4.6.4.2 Identification of input parameters

- Current value of the underlying asset (S_0) = \$160 thousands

- Strike price/option's exercise price (X) = \$400 thousands
- Option life of the investment (T) = 4 years
- Chosen interval size (δt) = 1
- Volatility of the asset value (σ) = 30%
- Risk-free interest rate during the life of the option (r_f) = 5%

4.6.4.3 Calculation of input parameters

$$\text{Up factor } (u) = e^{\sigma\sqrt{\delta t}} = e^{0.30\sqrt{1}} = 1.350$$

$$\text{Down factor } (d) = 1/u = 1/1.350 = 0.741$$

$$p = (e^{r\delta t} - d) / (u - d) = (e^{0.05*1} - 0.741) / (1.350 - 0.741) = 0.510$$

4.6.4.4 Generation of binomial tree

Building the tree using one year time intervals for four years to calculate the value of the asset over the option's life. Starting with (S_0) at the first node on the left and multiplied by the up factor and down factor to obtain S_{0u} ($\$160 \text{ thousands} * 1.350 = \216 thousands) and S_{0d} ($\$160 \text{ thousands} * 0.741 = \119 thousands). We have to continue moving to the right. This has to continue in a similar fashion for every node of the tree until the last step. Figure 4-13 displays the tree.

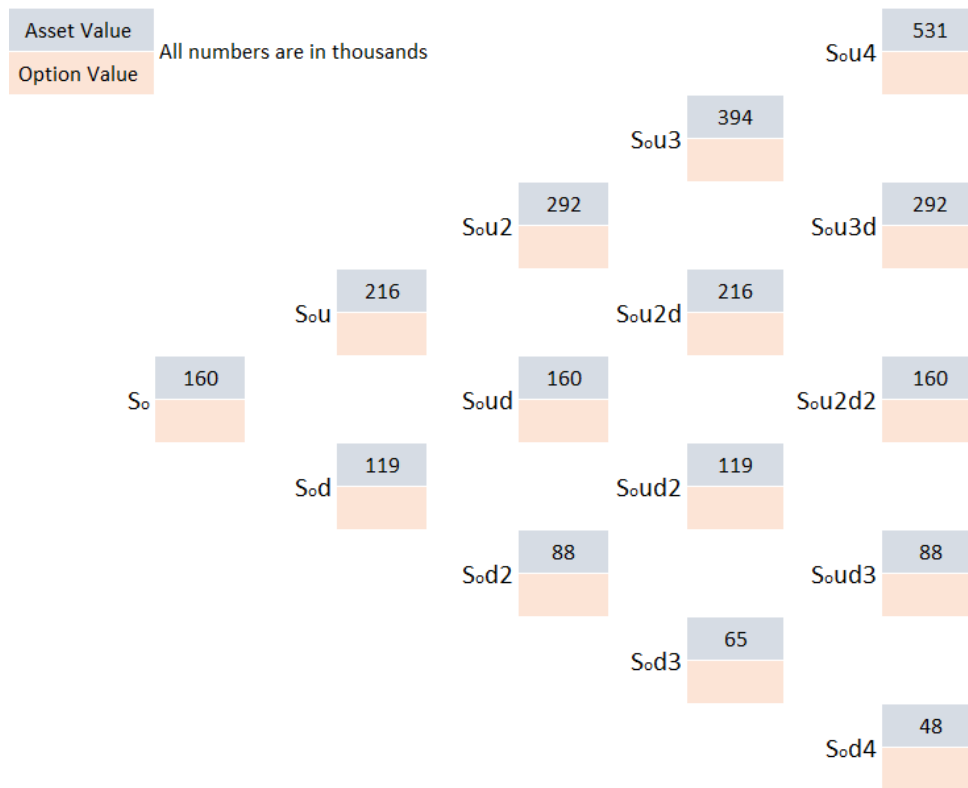

Figure 4-13: The binomial tree, with asset value, of option to adopt simulation-based training

4.6.4.5 Calculating the options value at each node

The option value is to be calculated using backward induction. Each node represents the value maximization of continuation with the current training and development program versus the adopting the simulation-based training at the cost of \$400 thousand. At each node, there are the options to either continue with the existing programs or to adopt the simulation-based training and committing the investment.

Starting with the terminal nodes that represent the last time step. At node S_{ou4} , the expected asset value is \$531 thousand. However, if we invested \$400 thousand and adopted the simulation-based training and achieved the threefold of savings, the asset value would be $(3 * \$531 \text{ thousands} - \$400 \text{ thousand} = 1,194 \text{ thousand})$. Since we want to maximize the return, we will adopt the simulation-based training rather than continue with the existing program, because the investment results in an asset value of 1,194 thousand, whereas continuation would yield a value of \$531 thousand only. Thus the option value would become \$1,194 thousand.

At node S_{ou2d2} , the expected asset value of the current training program is \$160 thousand. However, investing \$400 thousands for the new training and increasing the saving by threefold will yield $(3 * \$160 \text{ thousands} - \$400 \text{ thousand} = \$80 \text{ thousand})$. To maximize out a return, we will continue without the simulation-based training because that will give us an asset value of \$160 thousand instead of \$80 thousand asset value with investing the \$400 thousands.

We have to continue with the intermediate nodes. Starting at the top, at node S_{ou3} , we will have to calculate the expected value of the assets for maintaining the option open and assuring for optimal decisions. The value at node S_{ou3} , is:

$$OVu^3 = [(p(OVu^4) + (1 - p)(OVu^3d)]. e^{-r\delta t}$$

$$OVu^3 = [(0.510(\$1,194 \text{ thousands}) + (1 - 0.510)(\$475 \text{ thousands})]. e^{-0.05(1)}$$

$$OVu^3 = \$800 \text{ thousands}$$

If the option is executed to invest in the simulation-based training program by spending the \$400 thousands, the expected value would be as follows:

$$(3 * 394 \text{ thousand}) - \$400 \text{ thousand} = \$782 \text{ thousand}$$

Since the value is less than \$800 thousands that corresponds to the alternative to continue, we would not exercise the new training option, and the option value would be \$800 thousand.

Similarly, at node S_{oud2} , the expected asset value for keeping the option open and accounting for the downstream optimal decisions, is

$$[(0.510(\$160 \text{ thousands}) + (1 - 0.510)(\$88 \text{ thousands})]. e^{-0.05(1)}$$

$$= \$119 \text{ thousand}$$

If, on the other hand, we exercise the option to adopt the new training at the cost of \$400 thousand, the expected asset value would be

$$(3 * 119 \text{ thousand}) - \$400 \text{ thousand} = -\$43 \text{ thousand}$$

Maximizing \$119 thousand versus -\$43 thousand, we would not exercise the new training option. Therefore, the option value at this node would be \$119 thousand.

We complete the option valuation tree to time 0 using the spreadsheet in Figure 4-14 built

for this purpose (Figure 4-15).

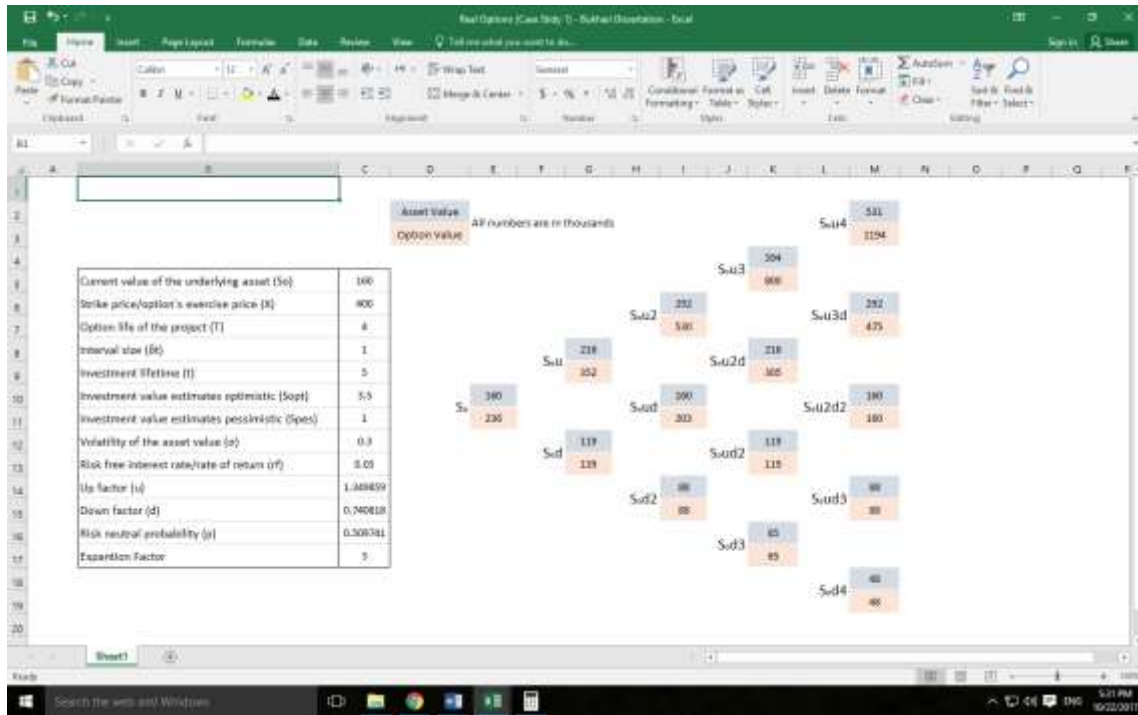

Figure 4-14: The spreadsheet developed to calculate the option value

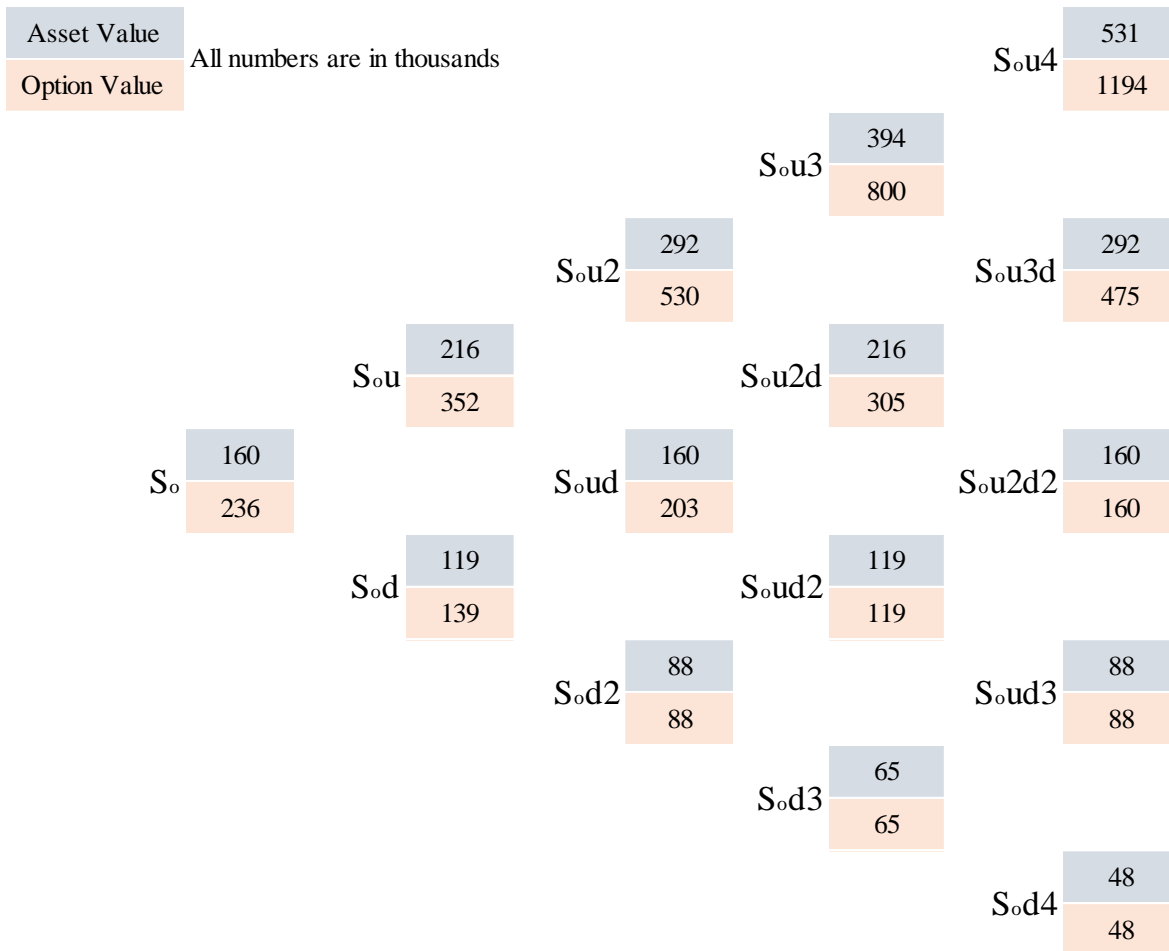

Figure 4-15: Binomial tree with option to adopt simulation-based training

4.6.4.6 Analyzing the results

We would like to compare the value of adopting the new training option based on discounted cash flows versus the analysis of the real options. The present value for the current training programs with the risk-adjusted discounted cash flow method is \$160 thousand. If the hospital has invested in the simulation-based training today, the extra value created is calculated as follows:

$$3 * \$160 \text{ thousands} - \$160 \text{ thousands} = \$320 \text{ thousands}$$

Since the investment is \$400 thousand, the NPV of this investment would be:

$$\$320 \text{ thousand} - \$400 \text{ thousand} = -\$80 \text{ thousand}$$

Investment will not be the right alternative. However, Real options suggests that the investment worth, taking into account the investment cost of \$400 thousand, is \$236 thousand. This means the net present value of the investment after subtracting the present value of the cash flows associated with the current programs is:

$$\$236 \text{ thousand} - \$160 \text{ thousand} = \$76 \text{ thousand}$$

Comparing this with the baseline (net present value) of -\$80 thousands for the investment, the additional value provided by the new training system is:

$$\$76 \text{ thousand} - (-\$80 \text{ thousand}) = \$156 \text{ thousand}$$

The difference is substantial and is the value added to the investment because of the Real Options approach which management can take into consideration in the decision-making process. Management may decide to keep the option to open at this time and exercise it when the

uncertainty clears.

4.7 Monte Carlo Simulation Analysis

Due to the high level of uncertainty in the investment, a tool that can deal with this essential aspect is needed. Monte Carlo simulation is one of the useful techniques for modeling and simulating situations where uncertainty is a key factor (Powell & Baker, 2009).

Monte Carlo simulation is a technique that use iteration to evaluate models using sets of random numbers as inputs. This technique is commonly used when the model involves multiple uncertain parameters. The Monte Carlo method is one of many methods for analyzing uncertainty propagation, where the goal is to evaluate how random variation, lack of knowledge, or error affects the sensitivity, performance, or reliability of the system that is being modeled (Wittwer, 2004).

Monte Carlo simulation is considered as a sampling method as the inputs are randomly generated from probability distributions in order to simulate the process of sampling from an actual population. Therefore, it requires identifying the distribution of the inputs that most closely matches the data, or best represents the current state of knowledge. The data generated from the simulation can be represented as probability distributions (or histograms) or converted to error bars, reliability predictions, tolerance zones, and confidence intervals (Wittwer, 2004). The following Figure 4-16: The principal of stochastic uncertainty propagation. Adopted from (Wittwer, 2004)

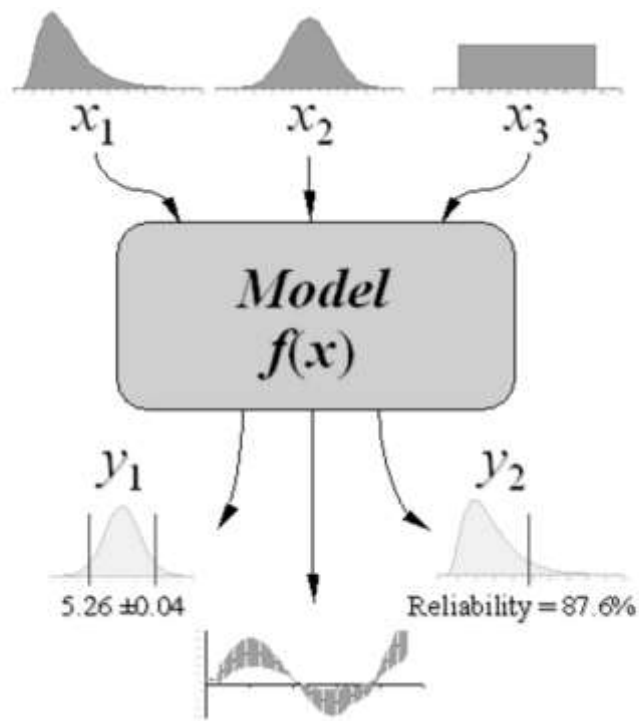

Figure 4-16: The principal of stochastic uncertainty propagation. Adopted from (Wittwer, 2004)

4.7.1 Steps to create Monte Carlo Simulation

Since Monte Carlo simulation comprises a great deal of iterations, it normally requires computers in order to perform the process. There are software applications that have the capability to perform Monte Carlo simulation. In this framework, the spreadsheet will be used for this purpose. The following are the general steps of creating Monte Carlo simulation.

The first step is to create a parametric model. In this framework, this parametric model will include the monetary value of the benefits and the cost of the simulation-based training programs, which are based on the cost and benefits structure. All these outputs eventually will be inputs to the ROI formula.

The second step is to generate a set of random inputs. This step requires identifying the probability distribution of each parameter. According to Wing Chau (1995), the problem of availability of historical data has led to the estimations to create a probability distribution for Monte Carlo simulation of construction costs. These estimations are often based on subjective data, estimates given by experienced estimators, and prior assumption of the shape of the probability distribution. In construction costs analysis, triangular probability distribution has always been considered for Monte Carlo Analysis. The reasons for adopting the assumption are that the triangular probability distribution simplifies the computational aspect of the modeling process and subjective estimates of the parameters of the triangular distribution (i.e., minimum, most likely and maximum) are comparatively easy to extract from estimators. Newton and Smith (1992), have adopted the assumption of the triangular distributions in their study of the methods of analyzing risk exposure in the cost estimates of high-quality offices. According to O'Hagan and Oakley (2004), the triangular distribution is only ever a simplified subjective assessment of an epistemic uncertainty. It results from the expert specifying a range and a mode, and then, following a failure to obtain anything more meaningful.

Therefore, this framework will consider using triangle distribution for the parameters due to the unavailability of historical data. In order to do that, experts in the field will estimate the most

likely value, maximum expected value, and minimum expected value that are needed to create the distribution.

Then, the model can be run for the number of iteration specified using a set of inputs every time including the best case scenario and worst case scenario and base case scenario. The output of this process can be represented as probability distribution as well. Then the results can be analyzed using histograms, summary statistics, confidence intervals, etc.

4.7.2 Return on investment evaluation

The return on investment evaluation has to be calculated according to the conditions set by the agency and/or healthcare business environment. The literature recommends the following formula:

$$\text{ROI (\%)} = \frac{\text{Net Benefit of Simulator}}{\text{Total Cost of Simulator}} * 100$$

Estimated cost and benefits are among the inputs of the simulator's ROI calculation process. Monte Carlo simulation will be used to deal with the uncertainty in the inputs. The presence of uncertainty in investment project always involves the presence of risk on investment, for example, *negative* ROI in a certain scenario (Hubbard, 2010). Therefore, it is essential to consider the different possibilities of cost and benefits to evaluate risks and to work on the mitigation. Prioritizing the risks based on impact is an important step in risk management. In the case of ROI, identifying the key measures that have a major impact on the ROI is essential for risk

management.

4.7.3 The application of Monte Carlo Simulation to the Case Study

In the case study of the correlation between the pediatric patient cardiopulmonary arrest (CPA) survival rates and a simulation-based mock codes at the University of Michigan tertiary care academic medical center discussed above, the expected cost savings over the 48 months of implementation was estimated to be \$790,000 and the total cost was about \$391,600.

In order to apply Monte Carlo analysis to consider the uncertainty of the inputs, we will need to create a probability distribution for each input. Since we do not have historical data that we can use to create the probability distribution, we will assume the following:

- The most likely value of the benefits is \$790,000
- The maximum expected value of the benefits is \$850,000
- The minimum expected value of the benefits is \$700,000

Based on these assumptions, the probability distribution of the expected benefits is displayed in the following Figure 4-17:

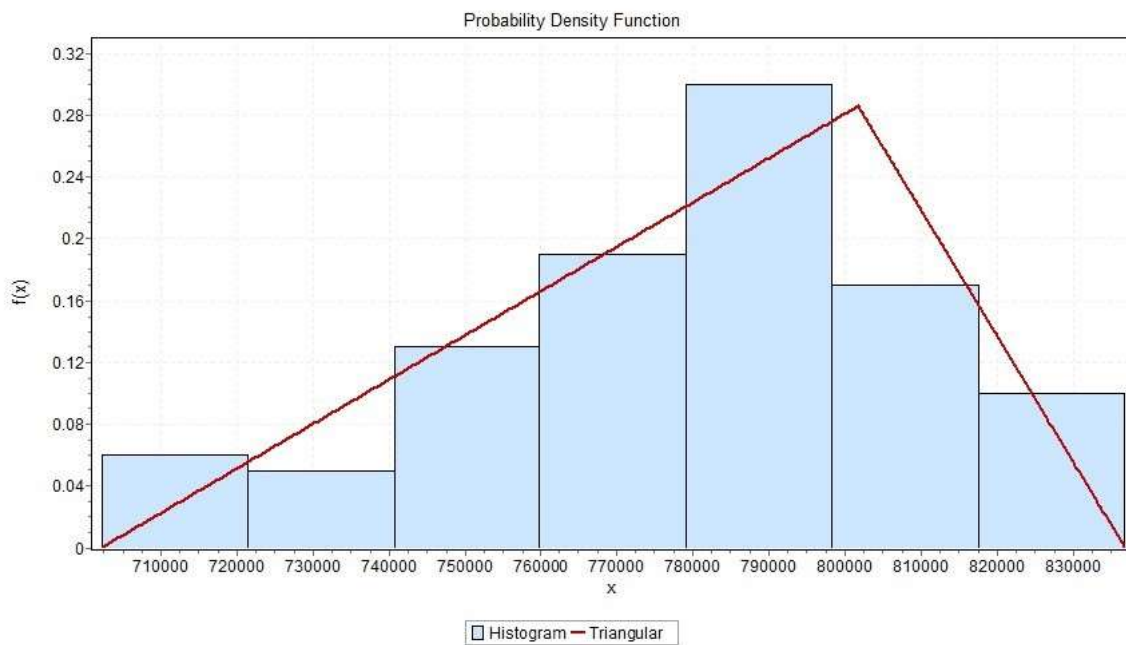

Figure 4-17: The probability distribution of the expected benefits

In order to create a probability distribution for the cost, we will assume the following:

- The most likely value of the cost is \$390,000
- The maximum expected value of the cost is \$450,000
- The minimum expected value of the cost is \$350,000

Based on these assumptions, the probability distribution of the expected cost will be as the following Figure 4-18:

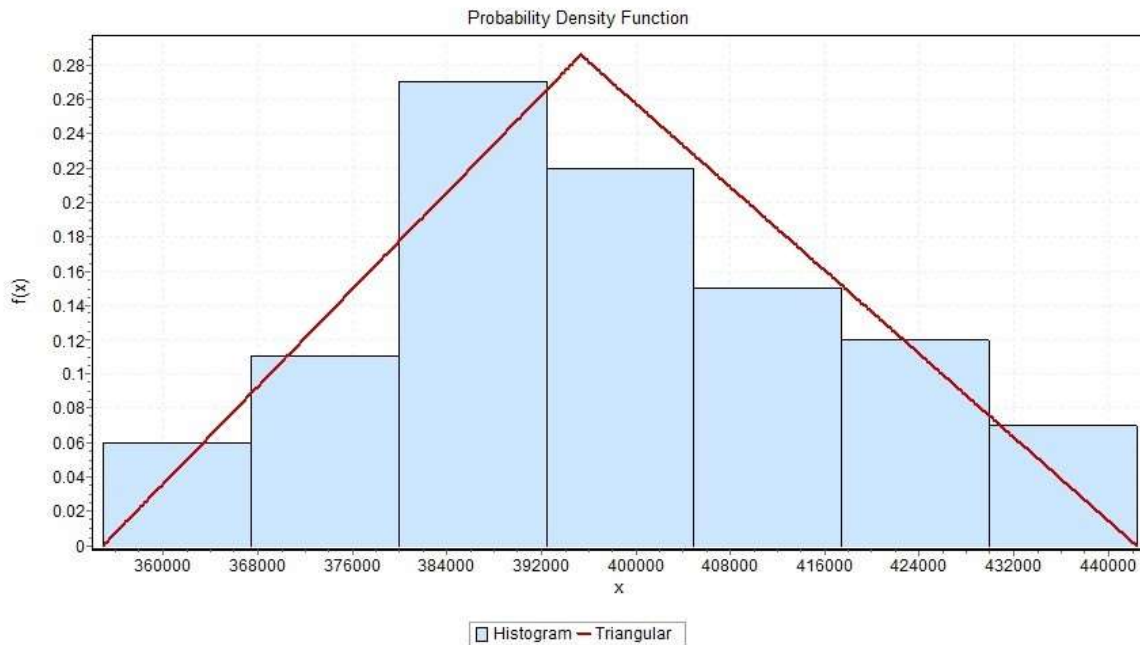

Figure 4-18: The probability distribution of the expected benefits

The next step is to generate 100 set of random inputs. Then, the model of the ROI can be run for the number of iteration specified, 100 times, using a set of inputs every time including the most likely scenario and worst case scenario and base case scenario. This step will be done using a spreadsheet.

The output of the model will be the following ROI distribution shown in Figure 4-19:

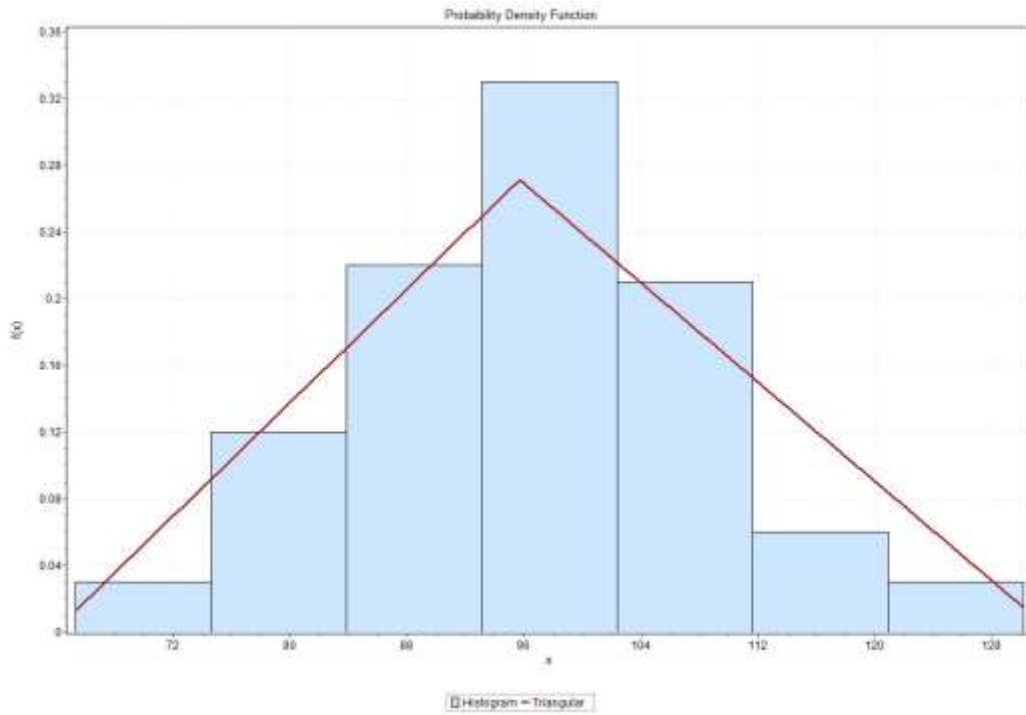

Figure 4-19: ROI distribution

This distribution indicates that the minimum expected ROI is about 65% with a probability of about 0.04 of occurrence, and the maximum expected ROI is about 130 with a probability of about 0.04 of occurrence, and the most likely ROI is about 96% with a probability of about 0.28 of occurrence. This information gives the decision maker a better view of the possible scenarios

based on the assumptions, which is extremely helpful for the evaluation and the decision-making process.

4.8 The final ROI framework for simulation-based training in healthcare

This framework is an integration of several methodologies and tools. The first part of the framework is the benefits and cost structure, which pays special attention to the qualitative and intangible benefits by considering the VMM and other previously existing models. This part also provides a systematic approach to convert qualitative and intangible benefits into monetary values to enable considering it when analyzing the ROI.

The second part of the framework is important to deal with the uncertainty associated with this type of investment. Monte Carlo simulation is a tool that considered multiple scenarios of input sets instead of a single set of inputs. This multiple scenarios consideration help decision makers to realize the range of expected outcomes and, consequently, make better investment decisions.

The third part of the framework considers an advanced value analysis of the investment. It goes beyond the DCF methodologies like NPV that consider a single scenario for the cash flow to Real Options Analysis that consider the flexibility over the lifetime of the investment when evaluating the value of the investment.

The following Figure 4-20 summarize the framework.

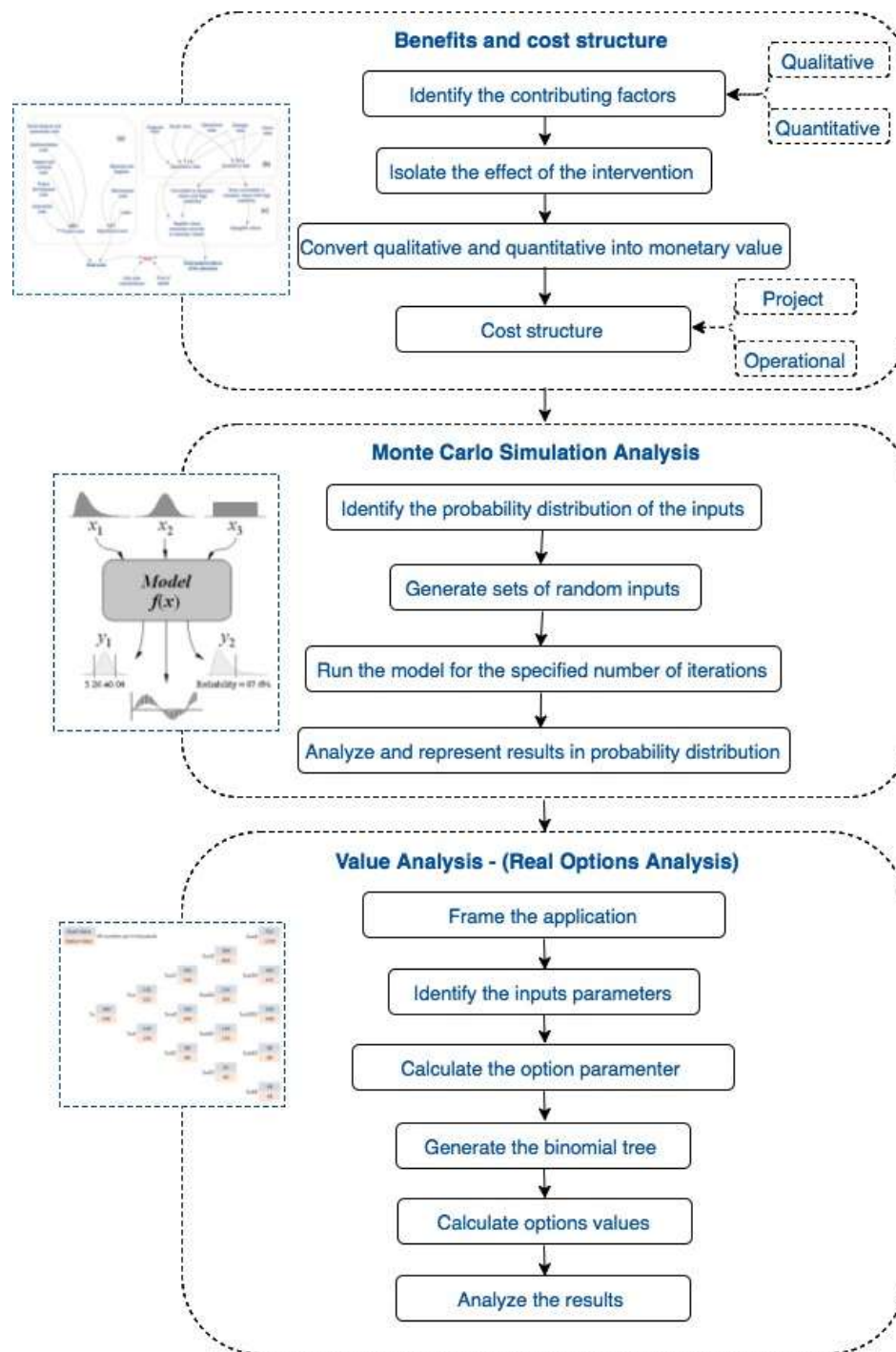

Figure 4-20: ROI Framework

CHAPTER 5: CASE STUDY AND VALIDATION

5.1 Introduction

The case study in this chapter will demonstrate the application of the entire framework. It provides real data from research that examined the impact of simulation-based training on the mortality rate of pediatric patients in the pediatric intensive care unit (PICU) of San Juan de Dios General Hospital (SJGH) in Guatemala.

5.2 The Experiment of the environment

Based on the records from Moya et al. (2016),

- Most of the patients who needed the PICU at SJGH are from poor and remote areas.
- In a sample of 190 parents of children admitted to PICUs.
- 150 were illiterate or incomplete elementary school.
- 105 disintegrated homes.
- 119 rural provenances.
- These facts reflect the bad life condition and the real need for the better medical attention of those patients.

The following Table 5-1 and graph in Figure 5-1 and Figure 5-2 represent the survival ratio at the PICU at SJGH. Although the survival rate over the 12 months records does not show a significant change, the records show a noticeable reduction in the monthly total number of patients. According to Dr. Luis Moya, the director of the simulation-based training center at the hospital,

this reduction is due to the lower performance of the staff in the last six months compared with the first six-month staff.

Table 5-1: The survivals rate at PICU

Month	Number of patients	Survived	Died	Survival ratio
Jan	81	52	29	64%
Feb	82	59	23	72%
Mar	79	50	29	63%
Apr	71	43	28	61%
May	83	59	24	71%
Jun	81	37	44	46%
Jul	71	51	20	72%
Aug	56	30	26	54%
Sep	48	32	16	67%
Oct	48	33	15	69%
Nov	49	34	15	69%
Dec	47	28	19	60%

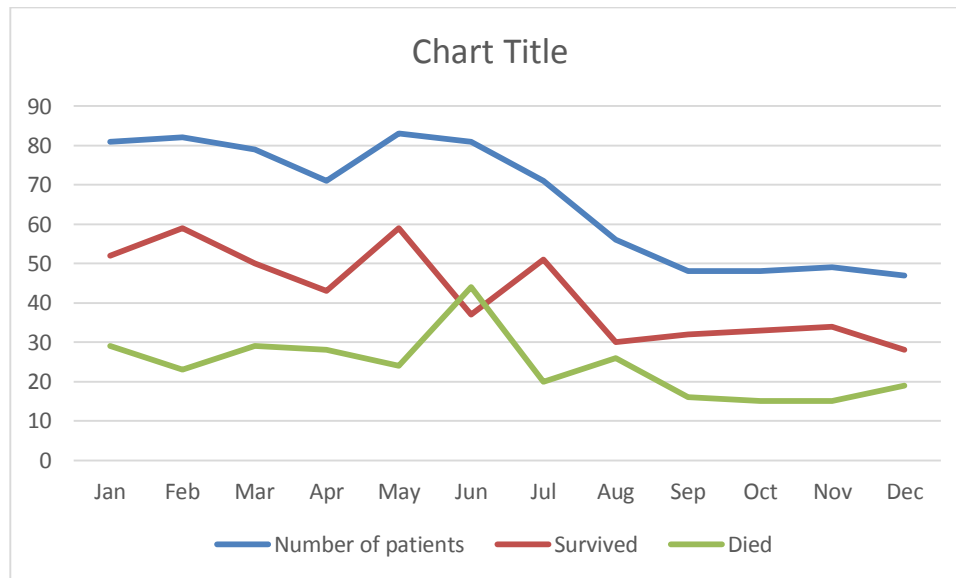

Figure 5-1: Comparing the number of patients, survived, and died patients over 12-month period

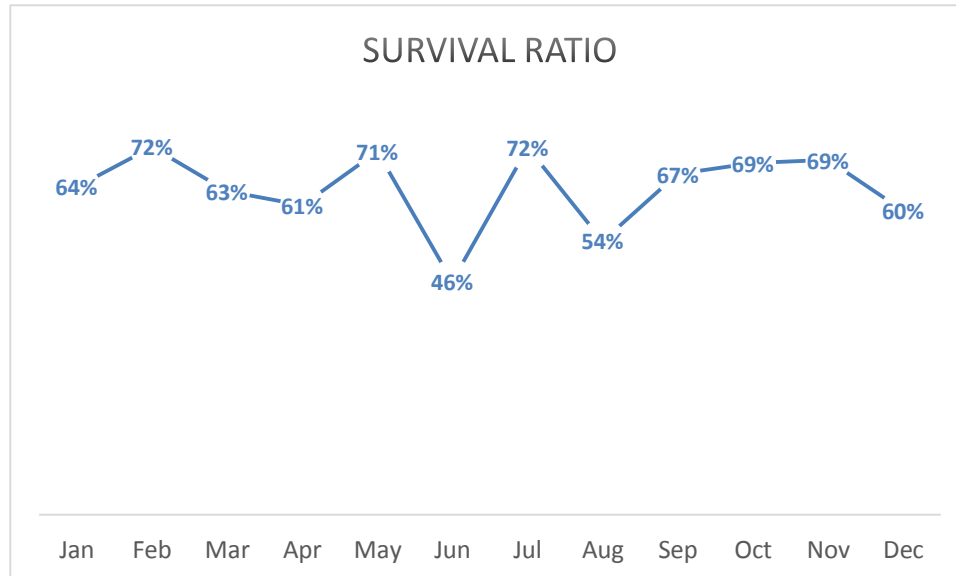

Figure 5-2: The survivals rate at PICU

The SJGH wanted to reduce mortality rate in the PICU. The management of the hospital believes that the mortality rate has a strong relationship with the team's decision-making ability, better performance, and physiological stability.

In 2014, the SOYUTZ Pediatric Emergency Simulation Center is inaugurated (Soyuz in Russian means union, utz in Mayan good, "good union") at the San Juan de Dios General Hospital where the Master Programs in Pediatrics and Critical Medicine, and Pediatric Intensive Care of the University of San Carlos of Guatemala are taught. This hospital is a state public hospital, and the university is equally public and state. In order to improve the team's decision-making ability, the performance, and the physiological stability, PICU of SJGH conducted a simulation-based training program in the Pediatric Emergency Simulation Center, SOYUTZ.

The development of Simulation-based training was for the training of students of undergraduate, postgraduate, nursing and workflow distribution as well as cognitive load. Looking for the improvement of processes making the implementation of Crew Resource Management (CRM) in critical areas and Simulation training to meet the need to handle more patients without the growth in infrastructure even to include areas for which it has not been designed. The training program implemented two sessions per week where different scenarios were practiced in the simulation center. CRM is a useful tool to reduce conflicts and improve performance in a multidisciplinary approach to reduce mortality.

The average number of patients treated in the Pediatric Emergency Room is 1,200 patients. The most common diagnoses Shock Septic, Ventilator Failure, pneumonia, trauma and other causes of shock are the main causes in 85% of cases. T statistical test has been made to compare two independent samples. The variables included the physiological records, length of stay, ventilation, and final outcomes.

The objective group was undergraduate students between the 5th and 6th year and graduate residence students in pediatric, anesthesia, and surgery. Those different students form a dynamic team to take care of the pediatric patients in the PICU.

The observed mortality was 35% lower in this area (2014 vs. 2015) in the same period. A Crew Resource Management-CRM program that includes 30 training sessions in simulation, teamwork, leadership and a trusting environment results in a reduction in mortality observed in 2015 than in 2014 with deteriorating conditions of care but improving the objectives in common.



Figure 5-3: SOYUTZ Simulation-based training center



Figure 5-4: Training session in SOYUTZ simulation-based training center



Figure 5-5: Training on mannequin



Figure 5-6: Training on infant mannequin



Figure 5-7: Dr. Luis Rabelo visiting SOYUTZ and meeting the director Dr. Luis Moya

5.3 The benefits and cost structure

The application of the benefits and cost structure is the first step in the framework. First, the benefits of the program will be analyzed. Then the cost will be calculated.

5.3.1 The benefits of the program

In this part, the key measures and factors will be identified, the qualitative and quantitative measure will be converted to tangible values, and the impact of the program will be evaluated.

5.3.1.1 Key Measures and Factors Identification

The framework recommends considering the five major categories of value from the VMM: direct, social, operational, strategic, and financial value. This case study will consider the intangible factor of social value, the strategic value of patient safety, and financial value. The critical measure that can combine all these types of values is the childhood mortality rate reduction.

Worldwide, a total of 6.282 million deaths occurred among children aged less than 5 years in 2013 (Kirigia, Muthuri, Nabyonga-Orem, & Kirigia, 2015). In this case study, we will focus on the major objective of the simulation-based training in the pediatric intensive care unit (PICU) of San Juan de Dios General Hospital (SJGH) in Guatemala, which is the reduction of mortality rate.

5.3.1.2 Converting qualitative and quantitative measure to tangible values

5.3.1.2.1 Steps to Convert Measures to Monetary Values

1. Identify the unit of measure:

The unit of measure in this case study will be the number of saved lives per year.

2. Determine the value of the unit:

According to Kirigia et al. (2015), Child mortalities have a negative impact on future macro-economics. They upsurge health expenditure, cause attrition of future labor and productivity, and impact investments in human and physical capital formation. In addition to that, Child deaths decrease future spending on goods and services; future labor force; future household savings, and henceforth investments; the number of future

taxpayers, and hence future tax revenues; and the number of future exports producers, and bleeding future exports earnings.

Kirigia et al. (2015), conducted a study to estimate expected/future productivity losses from child deaths in the WHO African Region in 2013 for use in advocacy for increased investments in child health services and other basic services that address children's welfare. A cost-of-illness method was used to estimate future non-health GDP losses related to child deaths. Future non-health GDP losses were discounted at 3 % discount rate. The discounted value of future non-health GDP loss due to the deaths of children under 5 years old in 2013 will be in the order of \$ 150.3 billion. The average non-health GDP lost per child death will be \$25,508 for low-income African countries.

The steps of the methodology are the followings:

1. Get the total number of child deaths (TCD).
2. Get the average age at death among under 5-year-old children (AAD). The average age at death is 2.5 years, 0 plus 5 years divided by 2.
3. Get life expectancy at birth (LE).
4. Get the per capita gross domestic product (\$ GDPPC).
5. Get the per capita total expenditure on health (PCTHE).
6. Calculate the per capita non-health gross domestic product in purchasing power parity (NHGDPPC) by subtracting per capita total health expenditure (PCTHE) from per capita GDP (\$GDPPC)

$$\text{NHGDPPC} = \text{GDPPC} - \text{PCTHE}$$

7. Select the proper discount rate. We are using a discount rate of 3 % because it was used likewise in the World Health Organization (WHO) health systems' performance assessment (Hill, 2001), the global burden of disease studies (WHO, 2013), the Institute for Health Metrics and Evaluation's global burden of disease studies (Lozano et al., 2012). In addition, a discount rate of 3% is conservative and appropriate for developing countries.

8. Calculate the undiscounted years of life lost under 5 years (YLL) = LE – AAD – the minimum legal employment age.

According to article 2 of the International Labor Organization (ILO) convention, the legal minimum age for employment is 15 years (C138 - Minimum Age Convention, 1973). Therefore, the future productive years of life lost equal each country's life expectancy at birth minus 14 years.

9. Calculate the discounted years of life lost (DYLL) using the following equation:

$$\sum_{t=1}^n 1/(1+r)^t$$

Where: r is the rate of discount of future losses; t is the first year of life lost, and n is the final year of the total number of years of life lost per child death as calculated in step 8.

10. Calculate the non-health GDP loss (NHGDPLoss) = DYLL * NHGDPPC * TCD

11. Calculate the average non-health GDP lost per child death

$$= \text{DYLL} * \$\text{NHGDPPC}$$

This case study will use the same methodology used in Kirigia et al. (2015) to calculate the loss per child in total non-health GDP in Guatemala. Below is the calculation of child death-related loss in non-health GDP uses actual information on Guatemala:

1. The total number of child deaths in Guatemala in 2015 (TCD) = 12,858 (UNICEF, 2015).
2. The average age at death among under 5 year old children (AAD), i.e. $(0 + 5)/2 = 2.5$ years
3. Guatemala life expectancy at birth (LE) in the year 2015 = 72 years (The World Bank, 2017).
4. Guatemala Per capita gross domestic product (\$ GDPPC) = \$ 3,923.57 (The World Bank, 2015)
5. Guatemala Per capita total expenditure on health (PCTHE) = \$ 473 (World Health Organization, 2014).
6. Guatemala NHGDPPC = GDPPC – PCTHE = \$ 3,923 – \$473 = \$ 3,450
7. Discount rate (r) = 3 %
8. Undiscounted years of life lost under 5 years (YLL) = LE – AAD – 14 years

$$= 72 - 2.5 - 14 = 55.5 \text{ years}$$
9. Discounted years of life lost (DYLL) is calculated using the following equation:

$$\sum_{t=1}^n 1/(1+r)^t$$

Using the above equation, r is the rate of discount of future losses = 0.03; t is the first year of life lost = 1, and n is the final year of the total number of years of life lost per child death = 55.5 years.

$$DYLL = 26.96546373 \text{ years}$$

$$10. \text{NHGDPLoss} = DYLL * \$ \text{NHGDPPC} * \text{TCD} = 26.96546373 * \$ 3,450 * 12,858 \\ = \$ 1,196,190,668$$

$$11. \text{The average non-health GDP lost per child death will be} = DYLL * \$ \text{NHGDPPC} \\ = 26.96546373 * \$ 3,450 = \$93,030$$

3. Calculate the change in performance:

Based on the records from Moya et al. (2016), the outcomes after introducing the training and reducing the mortality rate by 35% as in the following Table 5-2:

Table 5-2: Simulation-based training outcomes

The total number of PICU patients	1,200
The expected number of mortality before the training	103
The actual number of mortality after the training (35% less)	68

4. Determine the annual amount of change:

The following Table 5-3 will summarize the annual amount of change after the simulation-based training.

Table 5-3: The annual amount of change after the simulation-based training

The average number of PICU patients per year	1,200
The expected number of mortality before the simulation-based training	103
The actual number of mortality after the training (after 35% reduction)	68
The average of additional number of survivors per year after the training	35

5. Calculate the annual value of the improvement:

The annual amount of change will be =

The avrg. num. of additional survivors/yr * The avrg. GDP lost per child death

$$= 35 \text{ Patients} * \$93,030 = \$3,256,080 \text{ per year}$$

5.3.1.3 Isolating and Evaluating the Impact of the Simulator

In this case, the impact of the simulation-based training is \$3,256,080 per year.

5.3.1.4 Summary of benefits structure

The following Table 5-4 will calculate the expected present value (PV) of the benefits cash

flow of the program over 4 years using the discounted cash flow (DCF) method and using a discount rate of 5%. It shows that the PV of the benefits of the program is \$ 11,545,899.

Table 5-4: The discounted cash flow (DCF) of the program benefits

Year	Discount Rate	FV	PV
1	0.952380952	\$3,256,080	\$3,101,029
2	0.907029478	\$3,256,080	\$2,953,361
3	0.863837599	\$3,256,080	\$2,812,724
4	0.822702475	\$3,256,080	\$2,678,785
		PV	\$ 11,545,899

5.3.2 Cost Structure

The cost structure will include the two major categories of the project and operational cost. The project cost is a one time cost at the beginning of the program. The operational cost will extend over the lifetime if the program. The following sections will describe each category in detail.

5.3.2.1 Project phase cost

The following Table 5-5 show the details of the project phase cost. It includes the cost of purchasing the equipment that is needed for the training and another human resource cost that is

needed to design and set up the training program for the first time.

Table 5-5: Details and total of the project phase cost of the training

Item	Per unit cost	Units	Subtotal
Physician Startup	150	50	7,500
Faculty Educator Startup	100	80	8,000
Startup Coordinator	80	50	4,000
Simulation Technician Startup	80	80	6,400
Mannequins Purchase	40,000	-	40,000
Equipment (Ambulance)	250,000	1	250,000
TOTAL PROJECT COST			315,900

5.3.2.2 Operational phase cost

The following Table 5-6 describe the details of the annual operational cost of the program.

This is a reoccurring cost for the program, which will extend for four years.

Table 5-6: Details and total of the operational phase cost of the training

Item	Per unit cost	Units	Subtotal
Physicians	150	50	7,500
Faculty Educator	100	50	5,000
Training Coordinator	80	50	4,000
Simulation Technician	80	50	4,000
Simulator Maintenance	2,000	4	8,000
Materials/Supplies	1,000	4	4,000
Facilities	500	50	25,000
Cost of participating staff	1,000	50	50,000
TOTAL OPERATIONAL COST			107,500

5.3.2.3 Summary of cost structure of the program

In order to find the total cost of the program, we need to consider the number of years that the program will be implemented. For this case study, we will consider that the program will take four years. In this case:

The total operational cost for the four years will be: 4 Years * \$107,500 = \$430,000

The total program cost will be = total project cost + total operational cost

$$= \$315,900 + \$430,000 = \$745,900$$

The discounted rate future value (DRF) of the program cost using a discount rate of 5% will be \$697,090 as shown in Table 5-7 below:

Table 5-7: The discounted cash flow (DCF) of the program cost

Year	Discount Rate	FV	PV
0	1	\$315,900	\$315,900
1	0.952380952	\$107,500	\$102,381
2	0.907029478	\$107,500	\$97,506
3	0.863837599	\$107,500	\$92,863
4	0.822702475	\$107,500	\$88,441
		PV	\$697,090

5.3.3 Summary of benefits and cost structure

The following Table 5-8 will summarize the cost and benefits of the program.

Table 5-8: Summary of cost and benefits of the program

Program Benefits	
The expected benefits annual cash flow	\$3,256,080 per year
The total expected benefits cash flow in 4 years	\$13,024,320
PV: The discounted cash flow (DCF) of the program benefits	\$ 11,545,899
Program Cost	
Total project cost	\$315,900
The expected annual cost	\$107,500
The expected total program cost over the 4 years	\$745,900
PV: The discounted cash flow (DCF) of the program cost	\$697,090
NPV	\$10,848,809

5.4 Value Analysis and Real Option Approach

5.4.1 Framing the application

According to the data in the following tables, Table 5-9, Table 5-10, and Table 5-11, we will assume that the current level of medical education, training, and development program of this unit has an expected present value of savings of \$361 million over the 4 years using DCF. The management is expecting an improvement that will save \$373 million instead of \$361 million from the GDP over the 4 years due to the simulation-based training program to improve the team's decision-making ability, the performance, and the physiological stability. The cost DCF value of this training is expected to be about \$697,090 over the 4 years. Using management assumptions approach, the optimistic value of the investment would go up to 1200 million, and the pessimistic value would go down to 120 million.

Table 5-9: The expected additional annual savings after the training

The average number of PICU patients per year	1,200
The expected number of mortality before the training per year	103
The average non-health GDP lost per child death	\$93,030
The expected annual savings before the training = $(1,200 - 103) * \$93,030$	\$102,053,910
The expected annual savings after the training = $(1,200 - 68) * \$93,030$	\$105,309,960
The improvement factor	1.35

Table 5-10: The expected PV of savings of over 4 years before the training using DCF

Year	Discount Rate	FV	PV
0			
1	0.952380952	\$102,053,910.00	\$97,194,200.00
2	0.907029478	\$102,053,910.00	\$92,565,904.76
3	0.863837599	\$102,053,910.00	\$88,158,004.54
4	0.822702475	\$102,053,910.00	\$83,960,004.32
		PV	\$361,878,114

Table 5-11: The expected PV of savings of over 4 years after the training using DCF

Year	Discount Rate	FV	PV
0			
1	0.952380952	\$105,309,960	\$100,295,200.00
2	0.907029478	\$105,309,960	\$95,519,238.10
3	0.863837599	\$105,309,960	\$90,970,702.95
4	0.822702475	\$105,309,960	\$86,638,764.71
		PV	\$373,423,906

5.4.2 Identifying the input parameter

- Current value of the underlying asset (S_0) = \$367 million
- Strike price/option's exercise price (X) = \$697,090 \approx 1 million
- Option life of the investment (T) = 4 years
- Chosen interval size (δt) = 1
- Volatility of the asset value (σ) = $\ln(S_{opt}/S_{pes}) / 4\sqrt{t} = 30\%$
- Risk free interest rate/rate of return on a risk less asset during the life of the option (r_f) = 5%

5.4.3 Calculation of the option parameters

$$\text{Up factor } (u) = e^{\sigma\sqrt{\delta t}} = e^{0.30\sqrt{1}} = 1.33$$

$$\text{Down factor } (d) = 1/u = 1/1.33 = 0.75$$

$$p = (e^{r\delta t} - d) / (u - d) = (e^{0.05*1} - 0.75) / (1.33 - 0.75) = 0.52$$

Table 5-12: Summary of inputs and option parameters

Current value of the underlying asset (S_0)	361
Strike price/option's exercise price (X)	1
Option life of the project (T)	4
Interval size (δt)	1
Investment lifetime (t)	4
Investment value estimates optimistic (S_{opt})	1200
Investment value estimates pessimistic (S_{pes})	120
Volatility of the asset value (σ)= $\ln(S_{opt}/S_{pes}) / 4\sqrt{t}$	0.3
Risk free interest rate/rate of return (r_f)	0.05
Up factor (u)	1.33
Down factor (d)	0.75
Risk neutral probability (p)	0.52
Improvement Factor	1.35

5.4.4 Generation of the binomial tree

We have to build the binomial tree using one year intervals for four years to calculate the value of the asset over option's life. Starting with (S_0) at the first node on the left and multiplied by the up factor and down factor to obtain S_{0u} ($\$361 \text{ million} * 1.33 = \481 million) and S_{0d} ($\$361 \text{ million} * 0.75 = \271 million) respectively, for the very first time step. Moving to the right, we have to proceed for every node of the tree until the last time step. Figure 5-8 present the investment value at each node.

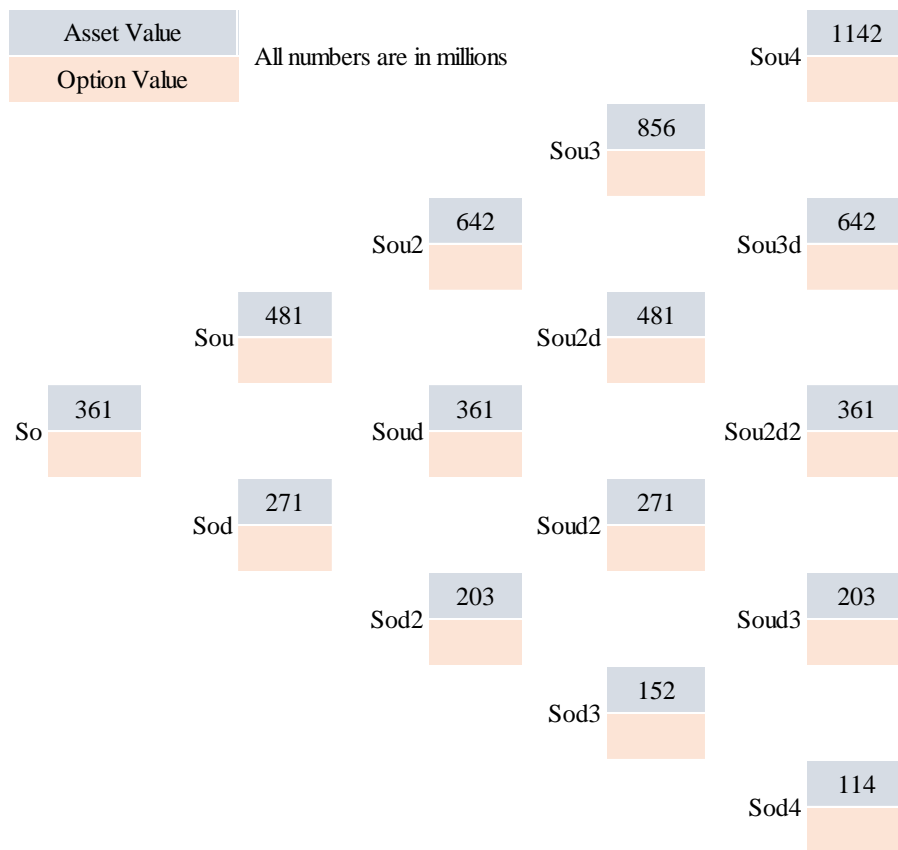

Figure 5-8: The binomial tree to adopt simulation-based training

5.4.5 Calculating the option values by backward induction

The option value is to be estimated using backward induction. Each node represents the maximization with the current training and development program versus adopting the simulation-based training program at the cost of \$1 million. At each node, there are the options to either continue with the existing programs or to adopt the simulation-based training and committing the investment.

Starting with the terminal nodes of the previous step. At node Sou4, the expected asset value is \$1142 million. However, if we invested about \$1 million thousand and adopted the simulation-based training and achieved the 35% improvement, the asset value would be $(1.35 * \$1142 \text{ million} - \$1 \text{ million} = \$1540 \text{ million})$. Since we would like to maximize the gain, we will adopt the simulation-based training rather than continue with the existing program, because the investment results in an asset value of \$1540 million, whereas continuation would yield a value of \$1142 million only. Therefore, the option at this node would become \$1540 million.

At node Sou2d2, the expected asset value of the current training program is \$361 million. However, investing \$1 million for the new training and increasing the saving by 35% will yield $(1.35 * \$361 \text{ million} - \$1 \text{ million} = \$486 \text{ million})$. To maximize our return, we will continue with the simulation-based training because that will give us an asset value of \$486 million instead of \$361 million asset value with investing the \$1 million. The same process is done for all the terminal nodes.

Next, we continue with the intermediate nodes. Starting at the top, at node Sou3, we have to estimate the expected value of the asset for preserving the option open and taking into consideration the downstream optimal decisions. The value at node Sou3 is:

$$OVu^3 = [(p(OVu^4) + (1 - p)(OVu^3d)]. e^{-r\delta t}$$

$$OVu^3 = [(0.52 (\$1540 \text{ million}) + (1 - 0.52)(\$866 \text{ million})]. e^{-0.05(1)}$$

$$OVu^3 = \$1155 \text{ million}$$

We complete the option valuation binomial tree all the way to time 0 using the following spreadsheet in Figure 5-9 developed for this purpose to get the following results in Figure 5-10.

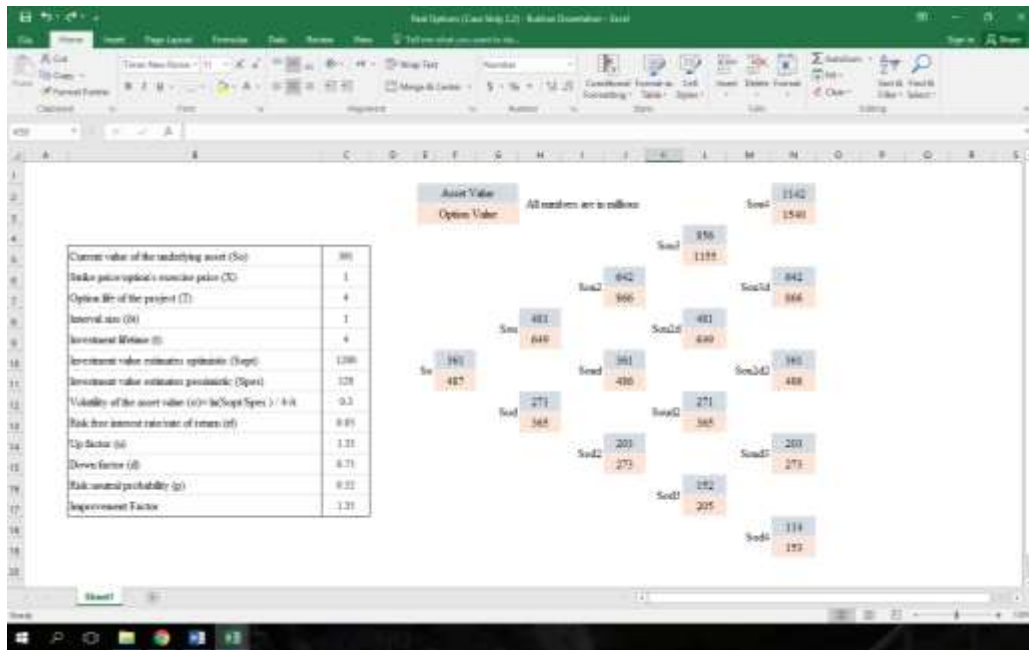

Figure 5-9: The spreadsheet developed to calculate the option value

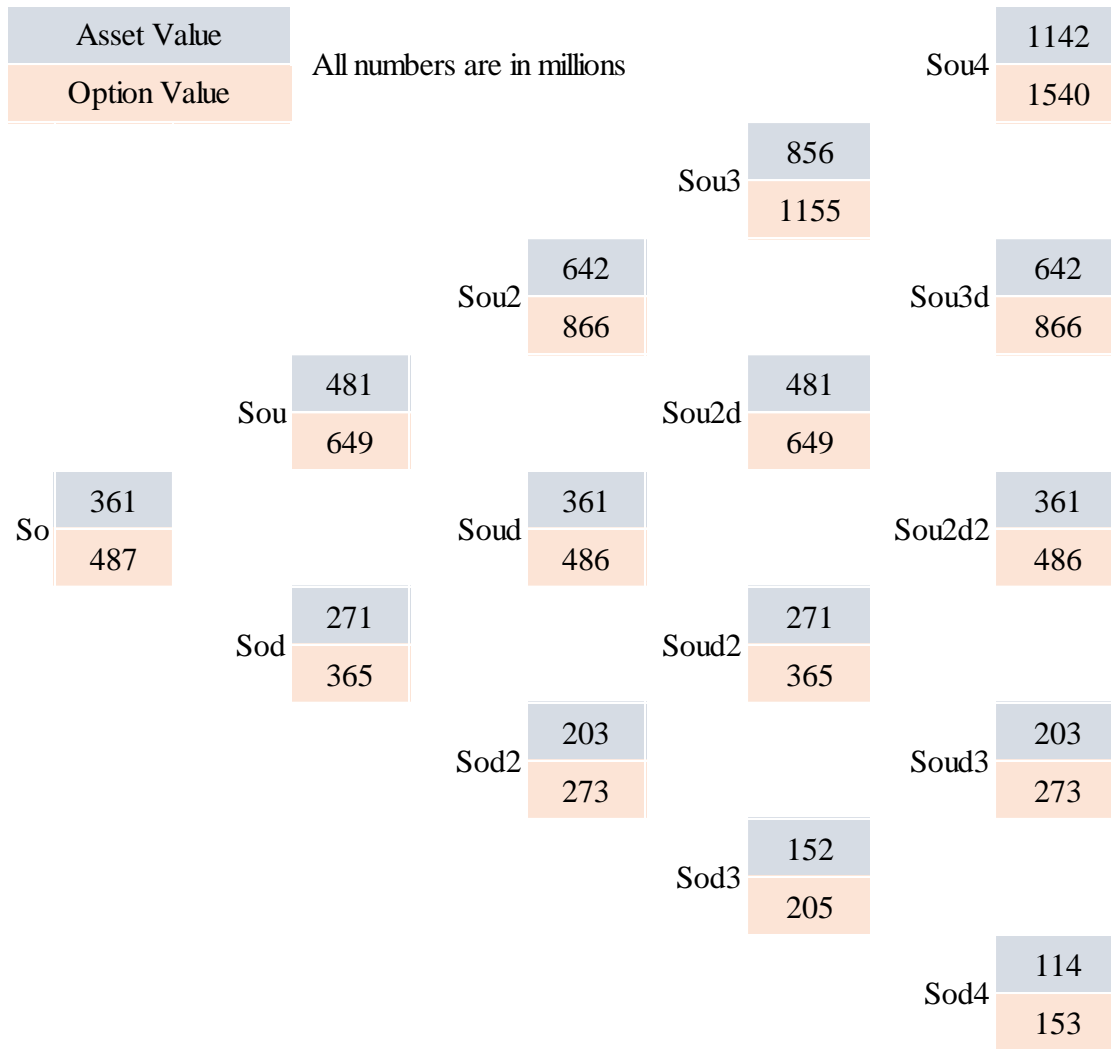

Figure 5-10: Binomial tree with option to adopt simulation-based training

5.4.6 Analyzing the results

We would like to evaluate the value of selecting the new training option based on DCF versus real options analysis. The present value for the current training programs with the risk-adjusted discounted cash flow method is \$10 million as per Table5-8.

The value of adopting the simulation-based training based on Real Options is \$487 million. The value of the savings without implementing the training is \$361 million. Therefore, the NPV of the investment based on Real Options is: \$487 million - \$361 million = \$126 million.

This is a very convincing figure, and the decision would be to invest by both methodologies, the discounted cash flow and Real Options. However, Real options analysis suggests higher value, \$126 million vs. \$10 million, as it takes into consideration the other possible scenarios.

5.5 Monte Carlo Simulation Analysis

5.5.1 Create a probability distribution for each input

In order to apply Monte Carlo analysis to consider the uncertainty of the inputs, we will need to create a probability distribution for each input. Based on the estimations that we get from the program director, Dr. Luis Moya. We will use the following inputs and assumptions to create the probability distribution:

- The most likely mortality improvement is 10%
- The maximum expected mortality improvement is 35%
- The minimum expected mortality improvement is 0%

Based on these assumptions, the probability distribution of the expected mortality improvement will be as shown in the following Figure 5-11:

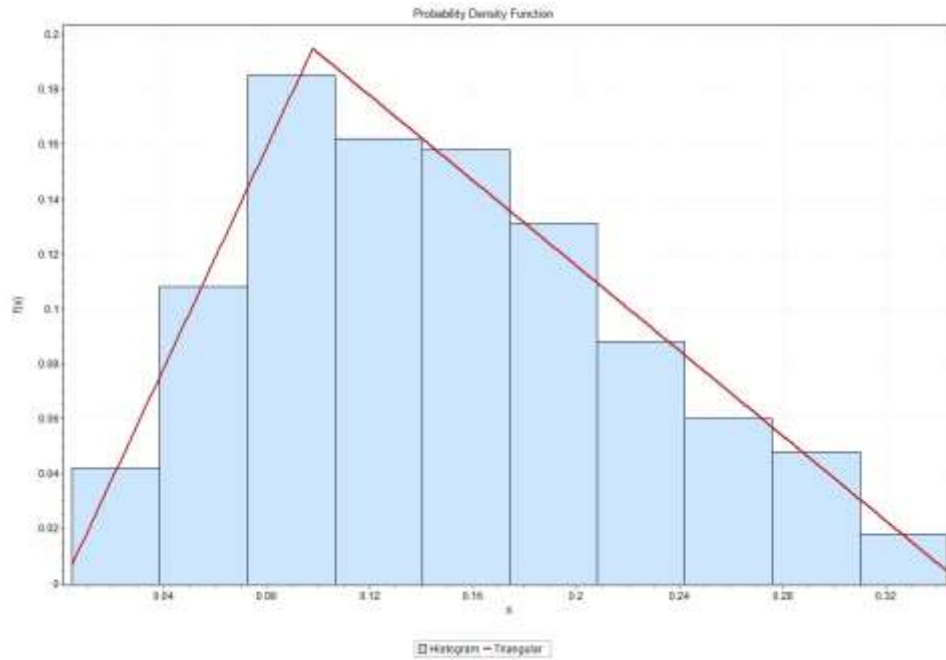

Figure 5-11: The probability distribution of the expected mortality improvement

In order to create a probability distribution for the cost, we will assume the following:

- The most likely value of the cost of the program over the four years is \$697,090
- The maximum expected value of the cost of the program over the four years is \$1,000,000
- The minimum expected value of the cost of the program over the four years is \$680,000

Based on these assumptions, the probability distribution of the expected cost will be as shown in the following Figure 5-12:

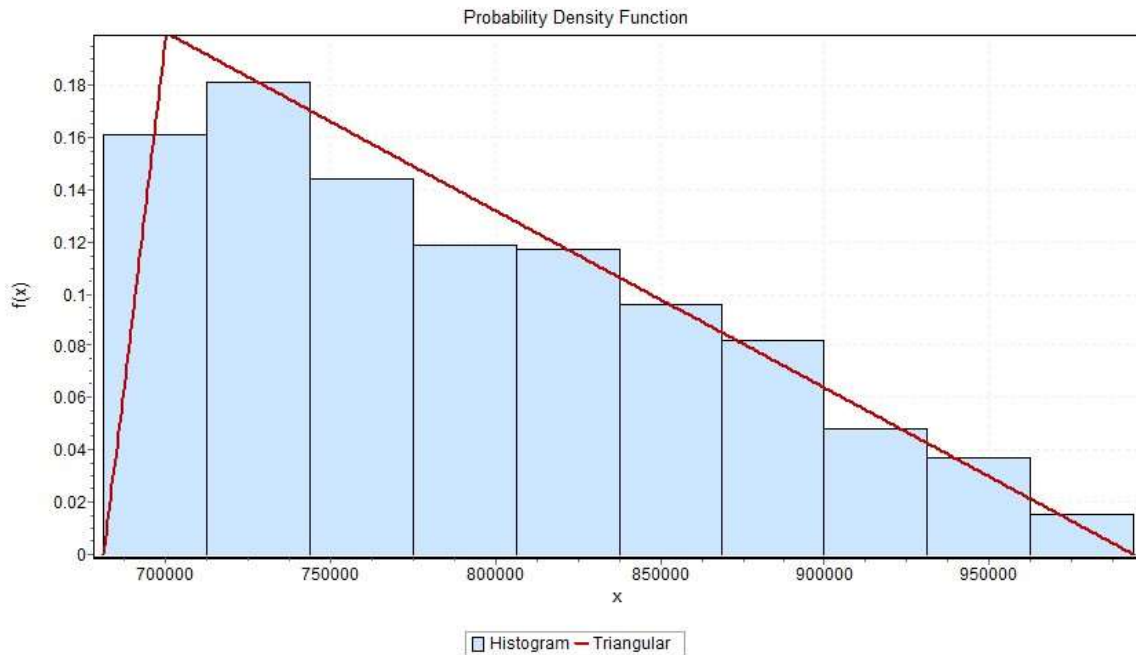

Figure 5-12: The probability distribution of the expected cost

5.5.2 Generate 1000 set of random inputs

The next step is to generate 1000 set of random inputs. Then, the model of the ROI can be run for the number of iteration specified, 1000 times, using a set of inputs every time including the most likely scenario and worst case scenario and base case scenario. This step will be done using spreadsheet.

5.5.3 Run the model

Calculating the net benefit of the simulator using the expected mortality improvement will be done using the following steps:

1. Calculate the additional annual savings due to the improvement data =

The expected saving after the training – the expected savings before the training

- The expected saving after the training = $(1,200 - (103 * \text{Improvement } \%) * \$93,030$
- The expected saving before the training = $(1,200 - 103) * \$93,030$

Where:

1,200 is the annual average number of patients.

103 is the mortality before the training.

\$93,030 is the average non-health GDP lost per child death.

Improvement % = random generated

2. Calculate the DCF for the savings over the 4 years.
3. Use the ROI formula

$$\text{ROI (\%)} = \frac{\text{Net Benefit of Simulator}}{\text{Total Cost of Simulator}} * 100$$

Where:

Net benefits of simulator = the DCF for the savings over the 4 years – the total cost

The total cost = random generated.

The above calculation will be done using a spreadsheet. The following Table 5-13 shows a sample of 7 out of 100 sets of data that has been generated and analyzed. The shaded columns represent the randomly generated data and the rest are calculated data.

Table 5-13: A sample of 7 out of 1000 sets of data that has been generated and analyzed

	% imp.	Exp. Benif. per Yr	Exp. Benif. Yr1	Exp. Benif. Yr2	Exp. Benif. Yr3	Exp. Benif. Yr4	4Yrs DCF Benif.	Cost	ROI
1	0.26413	2,530,903	2,410,381	2,295,579	2,186,270	2,082,174	8,974,404	695,344	1,191
2	0.12703	1,217,257	1,159,292	1,104,077	1,051,503	1,001,438	4,316,310	821,305	426
3	0.10242	981,421	934,685	890,168	847,781	807,415	3,480,049	743,419	368
4	0.26752	2,563,353	2,441,286	2,325,012	2,214,301	2,108,871	9,089,470	844,197	977
5	0.03689	353,453	336,622	320,589	305,323	290,786	1,253,320	951,505	32
6	0.07361	705,380	671,790	639,794	609,329	580,317	2,501,230	696,403	259
7	0.2397	2,296,816	2,187,442	2,083,258	1,984,059	1,889,591	8,144,350	850,011	858

The spreadsheet has been used to run the model for 1000 times and generate the following ROI probability distribution shown in Figure 5-13: ROI probability distribution.

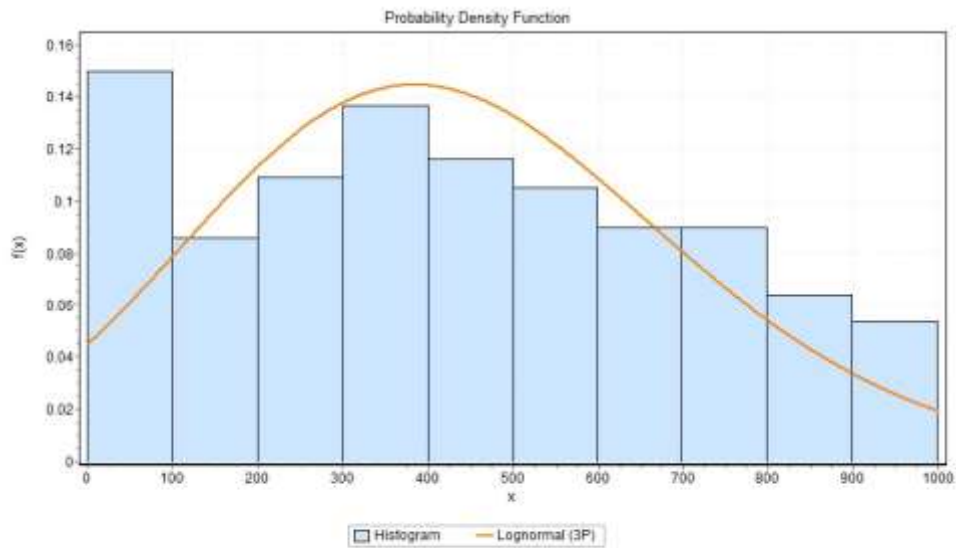

Figure 5-13: ROI probability distribution

5.5.4 Analyzing the results

This distribution indicates that the minimum expected ROI is about 0% with a probability of about 0.042 of occurrence, and the maximum expected ROI is about 1,000% with a probability of about 0.022 of occurrence, and the most likely ROI is about 400% with a probability of about 0.28 of occurrence. This information gives the decision maker a better view of the possible scenarios based on the assumptions, which is extremely helpful for the evaluation and the decision-making process.

5.6 Discussion

It is important to point out that the very high ROI in this case study is due to the low cost of \$745,900 (\$697,090 with DCF) of the investment over the 4 years compared to the significant improvement in the performance and additional survivals. Knowing that the loss savings per child survival is \$93,030, we can conclude that saving about 8 children only will break even the investment, but in this case study, the average additional annual survivals is 35 children. This is for one year only, and the investment was evaluated for 4 years.

This case study demonstrated the application of the framework. It is based on the available data. Even though T statistical test has been done to compare the results, it is quite difficult to confirm 100% that the improvement is directly or only related to the simulation-based training. On the other hand, there is a growing evidence about the relation between the relation between the performance and outcomes improvement and the healthcare training in general.

5.7 Educational Efficiency and Effectiveness

At this point of the research, it is important to introduce and discuss the concepts of the educational efficiency and educational effectiveness. At first, it is important to distinguish between the efficiency and the effectiveness of clear definition for each of them. According to Lockheed and Hanushek (1994), efficiency compares the inputs and their related outputs. A more efficient system achieves more output for a given set of resource, or obtain comparable levels of output for fewer inputs. While educational effectiveness refers to whether or not a specific set of resources has a positive and significant impact on achieving the desired results.

The evaluation of the efficiency of educational systems and training programs is complicated. This complication comes from the existence of other contributors to the improvement of students and trainees not only what they were exposed to during the educational program. Those contributors include intellectual and learning abilities, previous experience, attitudes, and other possible personal differences. Therefore, identifying the exact training outcomes for efficiency considerations is difficult. In other words, confirming that the portion of trainee growth, the marginal improvements, or development can be reasonably attributed to specific educational experiences requires more extensive analysis (Lockheed & Hanushek, 1994).

The evaluation of the educational efficiency of the programs discussed in this case study and the previous one, discussed within the development of the framework in chapter 4, is not an exception. However, the extreme expected ROI of more than 101% in the first case study and about 400% in the second case study gives a strong indication about the high educational efficiency of the discussed simulation-based training programs.

5.8 Ethical clearance

This study is completely an analysis of data from published secondary sources. Since human subjects were not involved, it did not require ethical clearance.

CHAPTER 6: CONCLUSION

6.1 Introduction

Clinical personnel, whether they are training or maintaining their abilities, need a safe way to practice decision-making and applied skills as individuals and in teams. Mechanisms for assuring opportunities to practice and rehearse using simulation-based methods have significant benefits for patient safety, not the least is because actual patients are not involved in the processes. Even though real world has stress and tension, the simulation-based practice provides an environment that offers the opportunity to focus on building and acquiring skills where learning is facilitated with less stress and tension on the practitioner, especially in high-risk clinical contexts where performance providing care for real patients could negatively affect the learning process. Therefore, simulation-based training offers an essential solution for providing clinical personnel the opportunity to learn, practice, and maintain their abilities without stress or risk to real patients' lives (Lateef, 2010).

Still, administrative decision makers that must determine if the investment in facilitating simulation-based environments is sufficiently beneficial with a convincing ROI compared to various alternatives that might be available. This has been a challenge that hindered the wide adoption of the simulation-based training due to its high cost and the inability to fully recognize the qualitative and indirect benefits to the healthcare system. This highlighted the importance of developing a comprehensive framework that has the capability to take in consideration the wide range of benefits that simulation-based training can bring to the healthcare system taking in consideration the characteristics of this specific field of investment. The major characteristics of investment in this field include the uncertainty, the qualitative nature of the major benefits, and

the diversity and a wide range of applications.

It is important to point out that the proposed framework offers the capability to consider a wide range of benefits and values that fall under any value category of the VMM including direct, social, operational, strategic, and financial values which enable more comprehensive evaluation for the ROI of the program. However, this would depend on the availability of the information that can help in converting these figures and information into monetary values to incorporate them into the ROI calculations. One example of an obvious added value is the legal obligations and consequences that are avoided as a result of improved clinical outcomes, such as survival rates for the considered case study. Another major value credited to extensive training, which could be achieved using simulation-based methods, is minimizing the medical errors. According to Makary and Daniel (2016), medical error is the third cause of death in the United States causing about 400,000 preventable deaths during the year 2013 alone. Understanding the real ROI and value of medical training, including highly effective simulation facilitated methods, provides a foundation for fostering investment in best practices that have a positive impact on patient safety and quality of care. These major objectives influence the whole of healthcare systems globally.

This comprehensive framework is an integration of several methodologies and tools. The first part of the framework is the benefits and cost structure, which pays special attention to the qualitative and intangible benefits by considering the VMM and other previously existing models. This part also provides a systematic approach to convert qualitative and intangible benefits into monetary values to enable considering it when analyzing the ROI.

The second part of the framework is important to deal with the uncertainty associated with this type of investment. Monte Carlo simulation is a tool that considered multiple scenarios of input sets instead of a single set of inputs. This multiple scenarios consideration help decision makers to realize the range of expected outcomes and, consequently, make better investment decisions.

The third part of the framework considers an advanced value analysis of the investment. It goes beyond the DCF methodologies like NPV that consider a single scenario for the cash flow to Real Options Analysis that consider the flexibility over the lifetime of the investment when evaluating the value of the investment.

The following Figure 6-1 summarizes the framework.

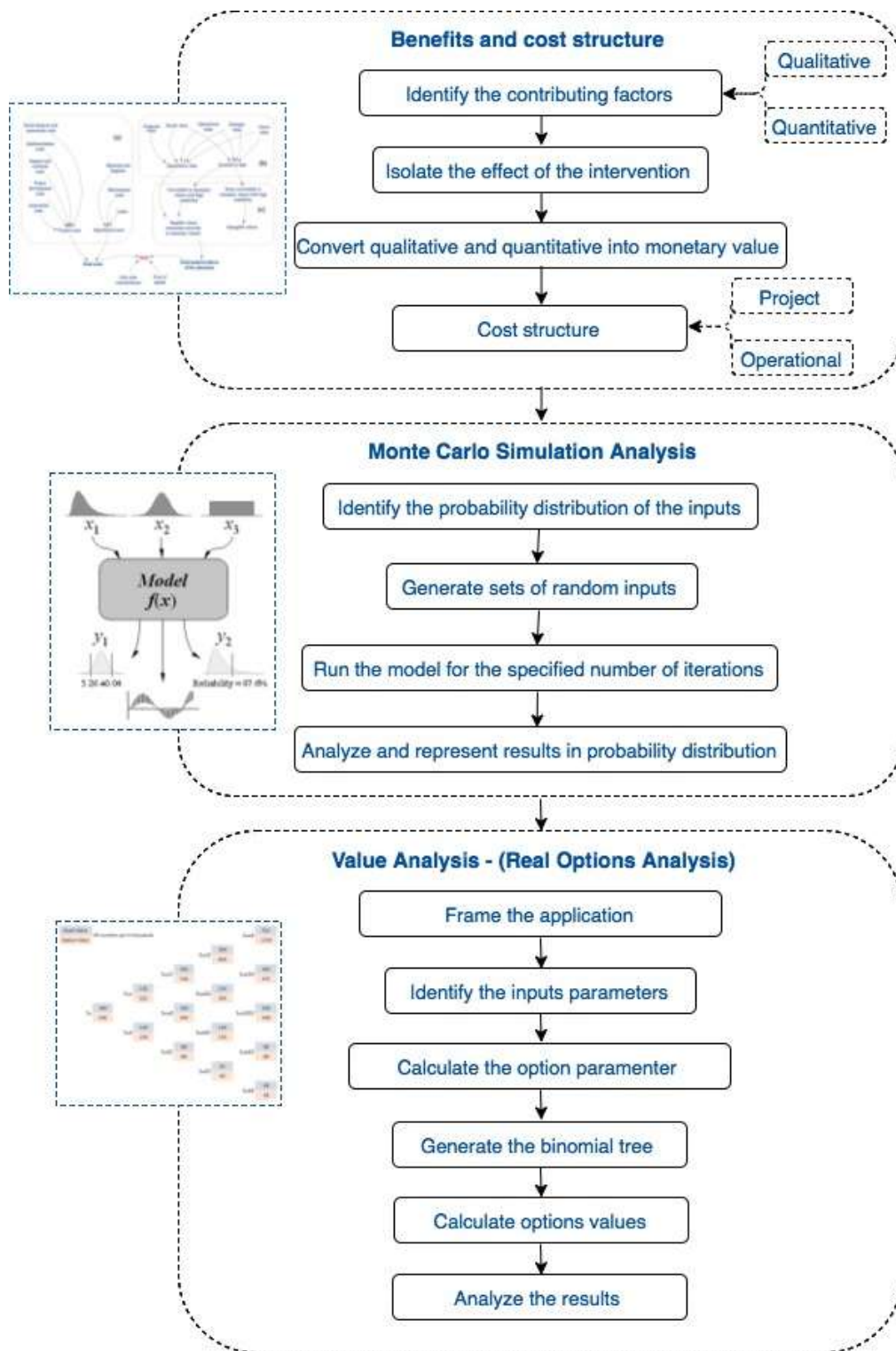

Figure 6-1: ROI Framework

6.2 Contribution to the Body of Knowledge

As a response to the identified gap in the literature review, which is the lack of a reliable and comprehensive way to measure the ROI of simulation-based training in healthcare organizations, the framework developed in this research aimed to provide a comprehensive solution to evaluate the ROI of simulation-based training in healthcare organizations.

The developed framework is an integration of multiple tools, techniques, and methodologies. It is a reliable and comprehensive framework to evaluate the ROI in simulation-based training in healthcare. The existence of such a comprehensive framework can help in recognizing the real value and benefits of this type of training. This, in turn, will promote this new approach to education, training, and development in healthcare organizations, which is one of essential systems for our societies. In fact, this framework provides a systematic approach to identify the multidimensional benefits so it can be recognized and taken into consideration in the decision-making process. In addition to that, it offers the mechanism to translate these benefits into monetary value and then, incorporate these benefits in the ROI calculation to reflect the real contribution of this form of training to the overall performance of the healthcare system.

It is important to point out that the proposed framework offers the capability to consider a wide range of benefits and values that fall under any value category of the Value Measurement Methodology (VMM) including direct, social, operational, strategic, and financial values which enable more comprehensive evaluation for the ROI of a program. It, also, benefits from the previous efforts of evaluating the ROI in the field of training in general and in the field of simulation-based training. These previous efforts include Kirkpatrick-Phillips Model for ROI of training programs, Frost and Sullivan Model, in addition to the guide of Measuring ROI in

Healthcare Improvements by Dr. Jack Phillips.

Furthermore, the framework reacted to the major characteristic of the uncertainty of the investment in simulation-based training in healthcare by adopting Monte Carlo analysis to deal with the high uncertainty in the investment. Moreover, and to benefit from the flexibility that to take the real options that are embedded within the lifecycle of the investment, the framework adopted the Real Options Analysis approach to take the possible advantage of the uncertainty.

One important lesson that we learned through this research is the importance of the educational efficiency, which we included in the benefits and cost structure as a contributing factor to the ROI. Although this factor has not been investigated in depth in this research, it should be considered for future research.

6.3 Future Work

A major work for the interested researchers in the field that can be considered for future work is to work on gathering the data from the existing simulation-based training programs, as the availability of data has been the major challenge for both: the development and the validation of this framework. Having more data could have made it easier to study the indirect benefits of this form of investment, which in turn will make the identification of the contribution factors more relevant. Additionally, it will facilitate the validation process for any newly developed framework.

Other possible future work is developing a comprehensive list of possible contributing factors, including benefits and cost, for the primary and secondary categories of the different forms of training mentioned in the taxonomy developed in this research. This will help with the implementation of the initial process of identifying the contributing factors of this framework. In addition to that, finding more reliable approaches to convert qualitative measures into monetary value will help to increase the factors considered in the ROI analysis.

We have included the education efficiency as a contributing factor in our ROI framework to refer to the possible factors that can impact the efficiency of the training program, which, consequently, will impact the outcomes of the training and overall ROI. Grober et al. (2004) in his study “The Educational Impact of Bench Model Fidelity on the Acquisition of Technical Skill: The Use of Clinically Relevant Outcome Measures” concluded that surgical skills training on low-fidelity bench models appears to be as effective as high-fidelity model training for the acquisition of technical skill among novice surgeons. In addition to the level of fidelity, we see other factors that need to be explored and taken into consideration like the personal abilities and the effect of the learning curve of the trainees, the experience and skill level of the instructor who is delivering the and supervising the training. These are examples of the important factors that can influence the outcomes of the training as well.

Educational efficiency can be perceived as the ratio of the monetary value of outcomes to the monetary value of the inputs. Proper consideration of the monetary value of outcomes is complex and influenced by several issues that are indirectly related to the measurements educational efficiency. These issues include the broader consequences of education, equity considerations, the specification of quantitative versus qualitative outputs, and cost minimization (Lockheed & Hanushek, 1994). Therefore, this area of educational efficiency has an important

consideration in future research.

Another possible future improvement is integrating change management. The objective of change management is to assess the transformation from the current state to the future state of the process, and the time delays. This will provide the nature of the relationships of the current practices and the future practices and how the transition takes place. One of the effective tools of change management analysis is the Matrix of Change.

The matrix of Change (MOC) is a tool that was developed by the Massachusetts Institute of Technology's Center for Coordination Science in association with the Center of eBusiness@MIT, and it was predominantly funded by Intel Corporation and British Telecom. MOC is a method developed to model change management; it identifies complimentary and interfering work practices that are classified into two matrices that are interconnected by the third one; the existing practices, the target practices, and a transitional matrix connecting the first two. The following Figure 6-2: The Matrix of Change. Adapted from (Elattar, 2014)

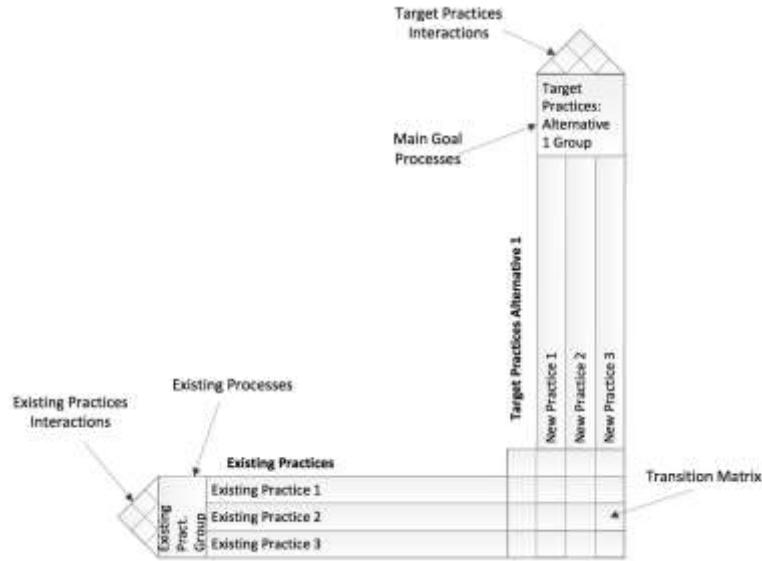

Figure 6-2: The Matrix of Change. Adapted from (Elattar, 2014)

The first matrix contains organization’s existing practices. It visualizes the practices that led the organization to its current situation and gives weight to rank their importance. It offers an understanding of a positive or a negative impact of the practice on the organization as a whole. It identifies the relationship between these practices and determines whether they contradict or complement one another.

The second matrix contains organization’s target practices and represents the targeted future of the organization. It may contain practices from the existing practices, and more often will display newly introduced practices based on the objectives of the organization. Like the existing practices, the target practices will also be ranked and compared with each other to identify relationship dynamics.

The third matrix is the transitional area, identifies the relationships between the existing practices and the target practices, and shows whether they contradict or complement one another. In general, a large number of contradictions between the existing practices and the target practices indicates a difficult transition. In contrast, a large number of practices complement each other indicate easier transition (Elattar, 2014).

Integrating the change management and the matrix of change will help to show the feasibility of the transformation, time delays, and taken opportunities. The MOC can be used to evaluate furthermore with actual case studies.

Case-Based Reasoning (CBR) is a well-established research field that involves the investigation of theoretical foundations, system development and practical application building of experience-based problem-solving. It uses old cases to solve new problems and does not require a lot of background knowledge on the part of the users (Guo, Peng, & Hu, 2013).

CBR is a computerized method that reuses and adapts solutions of formerly solved problems. Database management and machine learning techniques are used in order to perform the retrieval process. CBR contains four major processes: retrieve, reuse, revise, and retain, also known as the 4Rs. The CBR cycle, shown in Figure 6-3, is a part of machine learning created to fill in the gaps from available limitations in current rule-based systems and help in gaining more knowledge (Alshareef & Rabelo, 2016).

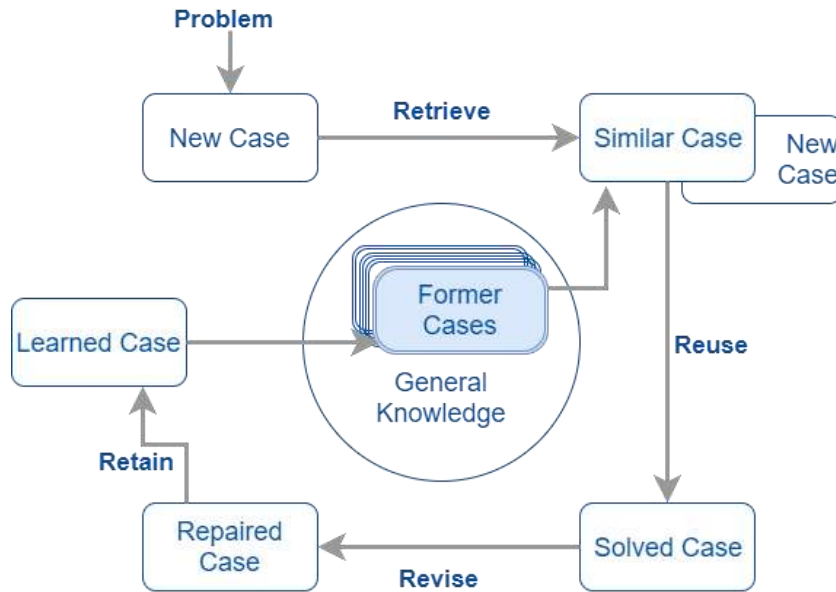

Figure 6-3: Case-Based Reasoning Cycle

Case-Based Reasoning can be considered in the future to provide expected improvements based on a knowledge-based of case studies provided. Therefore, these case studies can a starting point for building the database to be used for new reasoning.

LIST OF REFERENCES

- Abel, A. B., Dixit, A. K., Eberly, J. C., & Pindyck, R. S. (1996). *Options, the Value of Capital, and Investment. [electronic resource]*: Cambridge, Mass. : National Bureau of Economic Research, 1996.
- Ackroyd, S. (1992). *Data collection in context*: Longman Group United Kingdom.
- Acton, R. D., Chipman, J. G., Lunden, M., & Schmitz, C. C. (2015). Unanticipated teaching demands rise with simulation training: strategies for managing faculty workload. *Journal of Surgical Education, 72*(3), 522-529. doi:10.1016/j.jsurg.2014.10.013
- Aldridge, M., & Wanless, S. (2012). *Developing healthcare skills through simulation. [electronic resource]*: London : SAGE, 2012.
- Alshareef, K. H., & Rabelo, L. (2016). Using case-based reasoning for simulation modeling in healthcare: Orlando, Florida : University of Central Florida, 2016.
- Andel, C., Davidow, S. L., Hollander, M., & Moreno, D. A. (2012). The economics of health care quality and medical errors. *Journal of health care finance, 39*(1), 39.
- Andreatta, P., Saxton, E., Thompson, M., & Annich, G. (2011). Simulation-based mock codes significantly correlate with improved pediatric patient cardiopulmonary arrest survival rates. *Pediatric Critical Care Medicine, 12*(1), 33-38 36p.
doi:10.1097/PCC.0b013e3181e89270
- Aspden, P. (2006). IOM'S Preventing Medication Errors Report. *Journal of Pharmaceutical Finance, Economics & Policy, 15*(4), 3-4. doi:10.1300/j371v15n04_02
- Barrows, H. S. (1993). An overview of the uses of standardized patients for teaching and evaluating clinical skills. AAMC. *Academic Medicine, 68*(6), 443-451.

- Bernanke, B. (1980). *Irreversibility, Uncertainty, and Cyclical Investment*. [electronic resource]: Cambridge, Mass. : National Bureau of Economic Research, 1980.
- Bhasin, S. (2008). Lean and performance measurement. *Journal of Manufacturing Technology Management, 19(5)*, 670-684. doi:doi:10.1108/17410380810877311
- Borison, A. (2005). Real Options Analysis: Where Are the Emperor's Clothes? *Journal of Applied Corporate Finance, 17(2)*, 17-31. doi:10.1111/j.1745-6622.2005.00029.x
- Brennan, T. A., Leape, L. L., Laird, N. M., Hebert, L., Localio, A. R., Lawthers, A. G., . . . Hiatt, H. H. (1991). The incidence of adverse events and negligence in hospitalized patients: results of the Harvard Medical Practice Study I. *New England journal of medicine, 324(6)*, 370-376.
- Bukhari, H., Andreatta, P., Goldiez, B., & Rabelo, L. (2017). A framework for determining the return on investment of simulation-based training in health care. *Inquiry, 13*. doi:10.1177/0046958016687176
- Chiniara, G., Cole, G., Brisbin, K., Huffman, D., Cragg, B., Lamacchia, M., & Norman, D. (2013). Simulation in healthcare: A taxonomy and a conceptual framework for instructional design and media selection. *Medical Teacher, 35(8)*, e1380-e1395. doi:10.3109/0142159X.2012.733451
- Clark, C. C. (2008). *Classroom skills for nurse educators*: Jones & Bartlett Learning.
- Clarke, A., & Dawson, R. (1999). *Evaluation research*. [electronic resource] : an introduction to principles, methods and practice: London : SAGE, 1999.
- Cleland, J. A., Abe, K., & Rethans, J.-J. (2009). The use of simulated patients in medical education: AMEE Guide No 42. *Medical Teacher, 31(6)*, 477-486.

- Cohen, E. R., Feinglass, J., Barsuk, J. H., Barnard, C., O'Donnell, A., McGaghie, W. C., & Wayne, D. B. (2010). Cost savings from reduced catheter-related bloodstream infection after simulation-based education for residents in a medical intensive care unit. *Simulation in healthcare, 5*(2), 98-102.
- Creswell, J. W. (2013). *Qualitative inquiry and research design: Choosing among five approaches*: Sage.
- Csapi, V. (2013). Applying Real Options Theory in the Electrical Energy Sector. *Public Finance Quarterly (0031-496X), 58*(4), 469-483.
- C138 - Minimum Age Convention, 1973 (No. 138). (n.d.). Retrieved November 16, 2017, from https://www.ilo.org/dyn/normlex/en/f?p=NORMLEXPUB%3A12100%3A0%3A%3AN%3A%3AP12100_ILO_CODE%3AC138
- Dunn, W. F. (2004). *Simulators in critical care education and beyond*: Society of Critical Care Medicine.
- Durham, B. L. (2014). Using an Educational Module and Simulation Learning Experience to Improve Medication Safety.
- Elattar, A. A. (2014). *A holistic framework for transitional management. [electronic resource]*: Orlando, Fla. : University of Central Florida, 2014.
- Estrada, T., & Connolly, S. (2015). ROI of Leadership Training at National Cancer Institute. *Workforce Solutions Review, 6*(6), 10-13.
- Faezipour, M., & Ferreira, S. (2013a). A System Dynamics Perspective of Patient Satisfaction in Healthcare. *Procedia Computer Science, 16*, 148-156. doi:10.1016/j.procs.2013.01.016

- Faezipour, M., & Ferreira, S. (2013b). A System Dynamics Perspective of Patient Satisfaction in Healthcare. *Procedia Computer Science*, 16(0), 148-156.
doi:<http://dx.doi.org/10.1016/j.procs.2013.01.016>
- Fibuch, E., & Ahmed, A. (2015). PHYSICIAN TURNOVER: A COSTLY PROBLEM. *Physician Leadership Journal*, 2(3), 22-25.
- Frost, & Sullivan. (2004). *Return on investment study for medical simulation training: Immersion medical, inc. laparoscopy accutouch system. Industrial Research report.*
Retrieved from <http://www.healthleadersmedia.com/content/138774.pdf>
- Gardner, A. K., Scott, D. J., Pedowitz, R. A., Sweet, R. M., Feins, R. H., Deutsch, E. S., & Sachdeva, A. K. (2015). Best practices across surgical specialties relating to simulation-based training. *Surgery*, 158(5), 1395-1402. doi:10.1016/j.surg.2015.03.041
- Greiner, A. C., & Knebel, E. (2003). *Health professions education : a bridge to quality*: Washington, D.C. : National Academies Press, c2003.
- Grober, E. D., Hamstra, S. J., Wanzel, K. R., Reznick, R. K., Matsumoto, E. D., Sidhu, R. S., & Jarvi, K. A. (2004). The Educational Impact of Bench Model Fidelity on the Acquisition of Technical Skill: The Use of Clinically Relevant Outcome Measures. *Annals of Surgery*, 240(2), 374-381.
- Guo, Y., Peng, Y., & Hu, J. (2013). Research on high creative application of case-based reasoning system on engineering design. *Computers in Industry*, 64, 90-103. doi:10.1016/j.compind.2012.10.006
- Hill, K. (2001). The World Health Report 2000: Health Systems: Improving Performance. *Population and Development Review*(2).

- Hubbard, D. W. (2010). *How to measure anything. [electronic resource] : finding the value of "intangibles" in business*: Hoboken, N.J. : Wiley, c2010.
- 2nd ed.
- Hussain, M. M., & Gunasekaran, A. (2002). Non-financial management accounting measures in Finnish financial institutions. *European Business Review*, 14(3), 210.
- Issenberg, S., McGaghie, W. C., Hart, I. R., & et al. (1999). Simulation technology for health care professional skills training and assessment. *JAMA*, 282(9), 861-866.
- doi:10.1001/jama.282.9.861
- Jha, A. K., Duncan, B. W., & Bates, D. W. (2001). Simulator-based training and patient safety. *Making health care safer: A critical analysis of patient safety practices*, 45.
- Jones, J., & Hunter, D. (1995). Consensus methods for medical and health services research. *BMJ : British Medical Journal*, 311(7001), 376-380.
- Kirigia, J. M., Muthuri, R. D. K., Nabyonga-Orem, J., & Kirigia, D. G. (2015). Counting the cost of child mortality in the World Health Organization African region. *BMC Public Health*, 15(1), 1103. doi: 10.1186/s12889-015-2465-z
- Kodukula, P. (2006). *Project valuation using real options; a practitioner's guide*: Book News, Inc.
- Lahue, B. J., Pyenson, B., Iwasaki, K., Blumen, H. E., Forray, S., & Rothschild, J. M. (2012). National burden of preventable adverse drug events associated with inpatient injectable medications: healthcare and medical professional liability cost. *American health & drug benefits*, 5(7), 1.
- Lateef, F. (2008). What's new in emergencies, trauma, and shock? Role of simulation and ultrasound in acute care. *Journal of Emergencies, Trauma and Shock*, 1(1), 3.

- Lateef, F. (2010). Simulation-based learning: Just like the real thing. *Journal of Emergencies, Trauma and Shock*, 3(4), 348-352. doi:10.4103/0974-2700.70743
- Lockheed, M. E., & Hanushek, E. (1994). *Concepts of educational efficiency and effectiveness*.
- Lozano, R., Naghavi, M., Foreman, K., Lim, S., Shibuya, K., Aboyans, V., . . . Ahn, S. Y. (2012). Global and regional mortality from 235 causes of death for 20 age groups in 1990 and 2010: a systematic analysis for the Global Burden of Disease Study 2010. *The lancet*, 380(9859), 2095-2128.
- Luqman Hakim, S., Nur Naha Abu, M., & Nadiatulhuda, Z. (2015). Return on Investment (ROI) training evaluation in Malaysian SMEs: factors influencing the adoption processnull. *Development and Learning in Organizations: An International Journal*, 29(2), 18-21. doi:10.1108/DLO-05-2014-0035
- Makary, M. A., & Daniel, M. (2016). Medical error—the third leading cause of death in the US. *BMJ*, 353. doi:10.1136/bmj.i2139
- Marshall, J., & Heffes, E. M. (2004). Performance Measures Go Beyond Financials. *Financial Executive*, 20(2), 11-12.
- Martínez Ceseña, E. A., Mutale, J., & Rivas-Dávalos, F. (2013). Real options theory applied to electricity generation projects: A review. *Renewable and Sustainable Energy Reviews*, 19, 573-581. doi:10.1016/j.rser.2012.11.059
- Miller, L. T., & Park, C. S. (2002). DECISION-MAKING UNDER UNCERTAINTY-REAL OPTIONS TO THE RESCUE? *Engineering Economist*, 47(2), 105.
- Miyasaka, K. W., Buchholz, J., LaMarra, D., Karakousis, G. C., & Aggarwal, R. (2015). Development and implementation of a clinical pathway approach to simulation-based

training for foregut surgery. *Journal of Surgical Education*, 72(4), 625-635.

doi:10.1016/j.jsurg.2015.01.017

Moya, L., Castro, D., Orellana, V., Sim, L., Rivera, S., & Coronel, M. (2016). IMPACT OF DEVELOPMENT OF A SIMULATION CENTER IN MORTALITY OF PEDIATRIC PATIENTS IN CRITICAL STATE IN GUATEMALA. Paper presented at the The 8th World Congress on Pediatric Critical Care, Toronto, Canada.

Newton, S., & Smith, V. (1992). Methods of analysing risk exposure in the cost estimates of high quality offices. *Construction Management and Economics*, 10(5), 431-449.

O'Hagan, A., & Oakley, J. E. (2004). Probability is perfect, but we can't elicit it perfectly.

Reliability Engineering and System Safety, 85, 239-248. doi:10.1016/j.res.2004.03.014

Padhy, R. K., & Sahu, S. (2011). A Real Option based Six Sigma project evaluation and selection model. *International Journal of Project Management*, 29, 1091-1102.

doi:10.1016/j.ijproman.2011.01.011

Paige, J., Kozmenko, V., Morgan, B., Howell, D. S., Chauvin, S., Hilton, C., . . . O'Leary, J. P. (2007). 2007 APDS Spring meeting: From the Flight Deck to the Operating Room: An Initial Pilot Study of the Feasibility and Potential Impact of True Interdisciplinary Team Training using High-Fidelity Simulation. *Journal of Surgical Education*, 64, 369-377.

doi:10.1016/j.jsurg.2007.03.009

Pastrana, J., Rabelo, L., & Goldiez, B. (2014). *Determination of return on investment in healthcare simulation*. Paper presented at the IIE Annual Conference and Expo 2014, May 31, 2014 - June 3, 2014, 159, Rue Saint-Antoine Ouest, Montreal, QC, Canada.

- Phillips, J., Phillips, P. P., Phillips, Z. L., & Buzachero, V. V. (2013). *Measuring ROI in Healthcare: Tools and Techniques to Measure the Impact and ROI in Healthcare Improvement Projects and Programs*. New York: Mc Graw Hill Education.
- Phillips, J. J. (1991). *Handbook of training evaluation and measurement methods*: Houston : Gulf Pub. Co., c1991.
- 2nd ed.
- Phillips, J. J. (1997). *Handbook of training evaluation and measurement methods*: Houston, Tex. : Gulf Publishing, c1997.
- 3rd ed.
- Phillips, J. J. (2003). *Return on investment in training and performance improvement programs* (2nd ed. ed.). Amsterdam ; Boston: Butterworth-Heinemann.
- Phillips, J. J., & Phillips, P. P. (2007). *Show me the money : how to determine ROI in people, projects, and programs*: San Francisco, Calif. : Berrett-Koehler Publishers, c2007.
- 1st ed.
- Powell, S. G., & Baker, K. R. (2009). *Management science: The art of modeling with spreadsheets*: Wiley.
- Reddi, K. R., & Moon, Y. B. (2011). *System dynamics modeling of engineering change management in a collaborative environment*.
- Roelandt, J. P. (2013). *Evaluating and measuring the return on investment of an emergency center health care professional picture archiving and communication systems training program*. (73), ProQuest Information & Learning, US. Retrieved from <https://login.ezproxy.net.ucf.edu/login?auth=shibb&url=http://search.ebscohost.com/login>

n.aspx?direct=true&db=psyh&AN=2013-99111-014&site=eds-live&scope=site

Available from EBSCOhost psyh database.

Rondeau, K. V., Williams, E. S., & Wagar, T. H. (2009). Developing human capital: What is the impact on nurse turnover? *Journal of Nursing Management*, 17(6), 739-748.

doi:10.1111/j.1365-2834.2009.00988.x

Ross, S. A., Westerfield, R., & Jordan, B. D. (2008). *Fundamentals of corporate finance*: Tata McGraw-Hill Education.

Sanders, A., & Wilson, R. D. (2015). Simulation Training in Obstetrics and Gynaecology Residency Programs in Canada. *Journal Of Obstetrics And Gynaecology Canada: JOGC* = *Journal D'obstétrique Et Gynécologie Du Canada: JOGC*, 37(11), 1025-1032.

Schramm, W. (1971). Notes on Case Studies of Instructional Media Projects.

TheWorldBank. (2015). GDP per capita (current US\$). Retrieved from

<https://data.worldbank.org/indicator/NY.GDP.PCAP.CD>

TheWorldBank. (2017). Life expectancy at birth, total (years). Retrieved from

<https://data.worldbank.org/indicator/SP.DYN.LE00.IN?locations=GT>

Thomas, E. J., Studdert, D. M., Newhouse, J. P., Zbar, B. I. W., Howard, K. M., Williams, E. J., & Brennan, T. A. (1999). Cost of Medical Injuries in Utah and Colorado. *Inquiry*, 36(3), 255-264.

Training budgets cut as recession looms. (2008). *e.learning age*, 3-3.

Triantis, A. J. (2000). REAL OPTIONS AND CORPORATE RISK MANAGEMENT. *Journal of Applied Corporate Finance*, 13(2), 64.

- Trigeorgis, L. (2005). MAKING USE OF REAL OPTIONS SIMPLE: AN OVERVIEW AND APPLICATIONS IN FLEXIBLE/MODULAR DECISION-MAKING. *Engineering Economist*, 50(1), 25-53. doi:10.1080/00137910590917026
- UNICEF. (2015). Guatemala, Child Mortality Data. Retrieved from <https://data.unicef.org/country/gtm/>
- US Federal CIO Council. (2002). *Value measuring methodology: How to guide*. CIO Council, Best Practices Committee.
- Waldman, J. D., Kelly, F., Arora, S., & Smith, H. L. (2010). The shocking cost of turnover in health care...Reprinted with permission from *Healthcare Management Review* 29 (1), 2-7. *Health Care Management Review*, 35(3), 206-211 206p.
- Wayne, D. B., Didwania, A., Feinglass, J., Fudala, M. J., Barsuk, J. H., & McGaghie, W. C. (2008). Original Research: Simulation-Based Education Improves Quality of Care During Cardiac Arrest Team Responses at an Academic Teaching Hospital. A Case-Control Study. *Chest*, 133, 56-61. doi:10.1378/chest.07-0131
- Wing Chau, K. (1995). The validity of the triangular distribution assumption in Monte Carlo simulation of construction costs: empirical evidence from Hong Kong. *Construction Management and Economics*, 13(1), 15-21.
- Wittwer, J. (2004). Monte Carlo Simulation Basics. Retrieved from <https://www.vertex42.com/ExcelArticles/mc/MonteCarloSimulation.html>
- WHO, G. (2013). WHO methods and data sources for global burden of disease estimates 2000-2011. Geneva: Department of Health Statistics and Information Systems.
- WorldHealthOrganization. (2014). Guatemala Statistics. Retrieved from <http://www.who.int/countries/gtm/en/>

Yin, R. K. (2013). *Case study research: Design and methods*: Sage publications.

Zambrano, L. G., Merino, J. D. G., & Castellanos, A. R. (2011). *Impact of Investment in Human Capital on the Business Value*.

Zimmerman, D. M. (2016). Impacts & Innovations. Medication Safety: Simulation Education for New RNs Promises an Excellent Return on Investment (Vol. 34, pp. 49-51 43p). Pitman, New Jersey: Jannetti Publications, Inc.